

Surgical Instruments

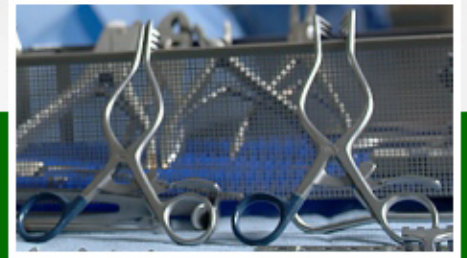

Ascender Surgical

Usman Nagar Bonkan, Sialkot- 51310, Pakistan
Cell: +92-346-6634928

Email: info@ascendersurgical.com

SURGICAL INSTRUMENTS

RETRACTORS



AS-5-920-01
Hooklet
16.5 cm,



Meyerding
AS-5-921-01
Hooklet
17.5 cm Fig. 1, 17.5 cm Fig. 2, 17.5 cm Fig. 3, 17.5 cm Fig. 4, 17.5 cm Fig. 5, 17.5 cm Fig. 6,



Senn-Green
AS-5-922-01
Hooklet
15 cm Fig. 1, 15 cm Fig. 2,



Ragnell-Davis
AS-5-923-14
Hooklet
14 cm,

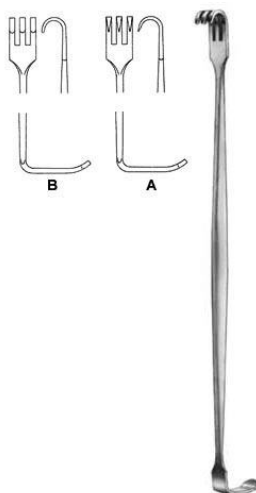

Senn-Miller
AS-5-924-16
Hooklet
16 cm,



Cushing
AS-5-925-20
Retractor
20.5 cm,

SURGICAL INSTRUMENTS

RETRACTORS

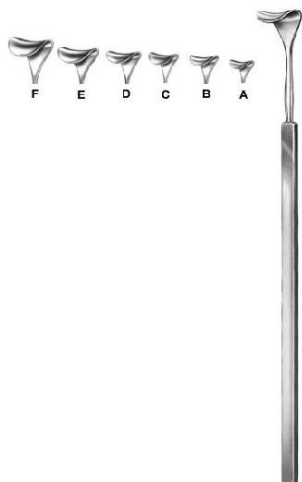

Cushing

AS-5-926-08

Saddle Hook

20.5 cm 8 mm wide, 20.5 cm 10 mm wide, 20.5 cm 12 mm wide, 20.5 cm 14 mm wide, 20.5 cm 16 mm wide, 20.5 cm 18 mm wide,

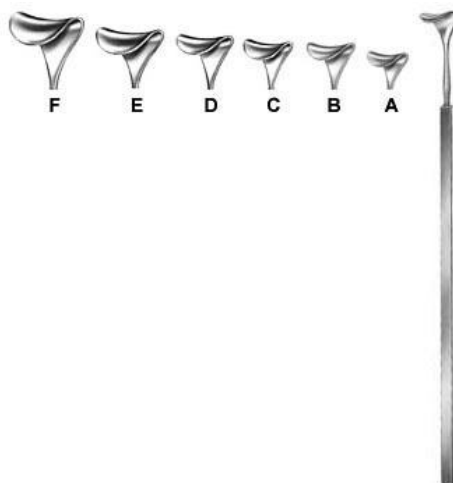

Cushing

AS-5-927-08

Saddle Hook 8 mm to 18 mm wide
24 cm,



Brom

AS-5-928-01

Vein Hook
19.5 cm,



Strandell-Stille

AS-5-929-01

Hooklet

19 cm Fig. 1, 19 cm Fig. 2,

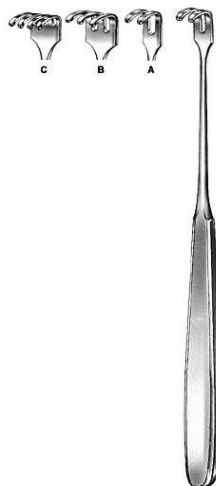

Klapp

AS-5-930-01

Retractor 12 x 6, 12 x 11, 15 x 11
17.5 cm,



AS-5-931-04

Hooklet
16.5 cm,

SURGICAL INSTRUMENTS

RETRACTORS

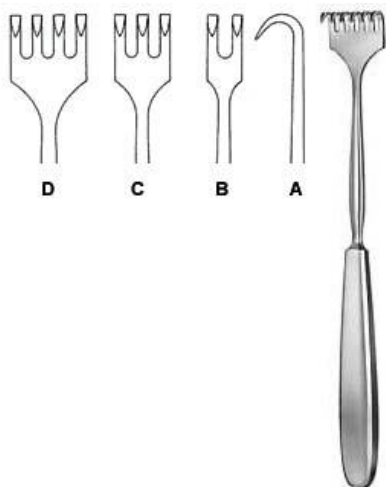

Volkmann
AS-5-932-01
Retractor
21.5 cm,

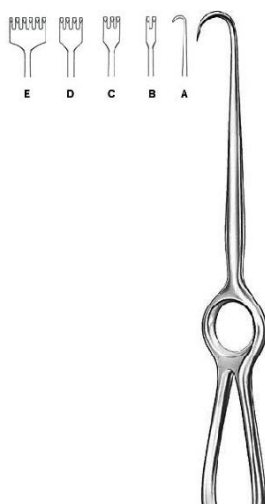

Volkmann
AS-5-933-01
Retractor
22 cm, 21.5 cm,

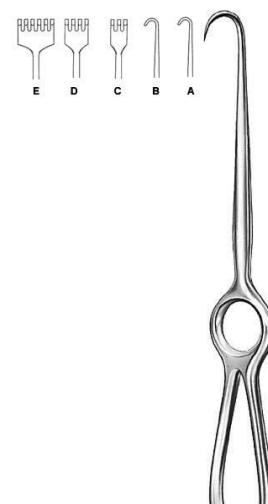

Kocher
AS-5-934-01
Retractor
22 cm,

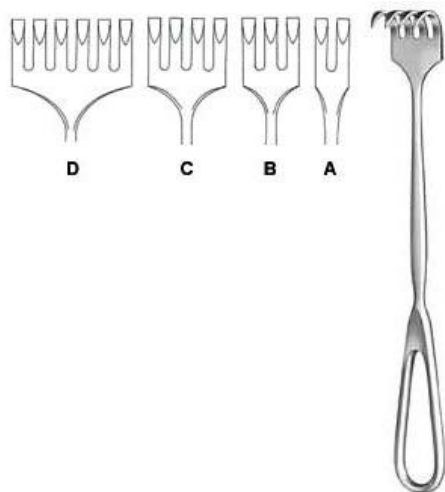

Martin
AS-5-935-02
Retractor
22.5 cm,

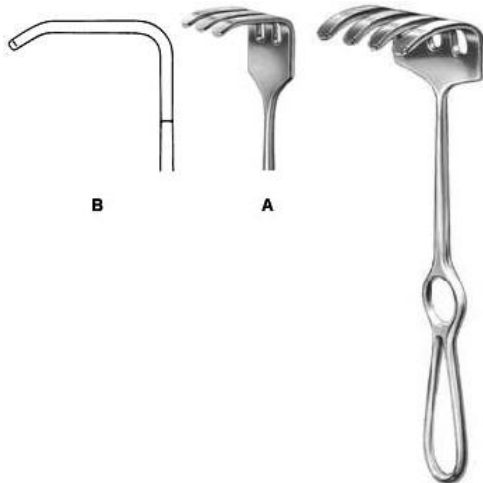

Ollier
AS-5-936-03
Retractor
23 cm 36 x 30, 23 cm 36 x 60,

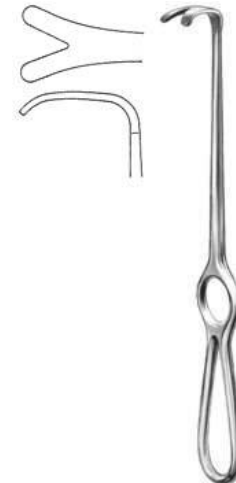

Wassmund
AS-5-937-02
Retractor
20.5 cm 33 x 21,

SURGICAL INSTRUMENTS

RETRACTORS

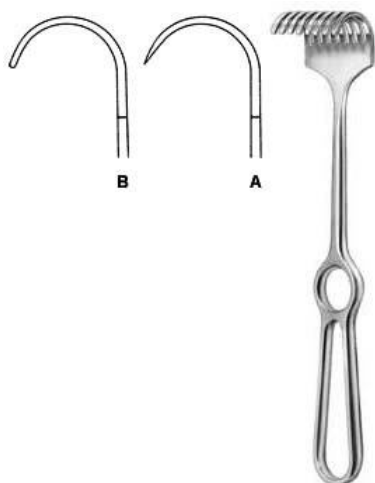

Korte
AS-5-938-08
Retractor
24.5 cm 40 x 30,

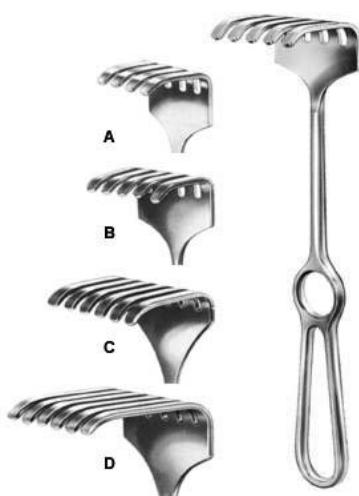

Israel
AS-5-939-04
Retractor
25.5 cm,

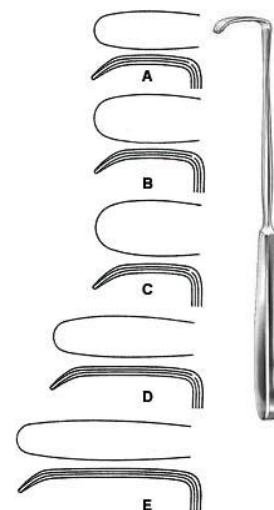

Langenbeck
AS-5-940-01
Retractor
22.5 cm 30 x 11 mm, 22.5 cm 30 x 14 mm, 22.5 cm 30 x 16 mm, 22.5 cm 40 x 11 mm, 22.5 cm 50 x 11 mm,

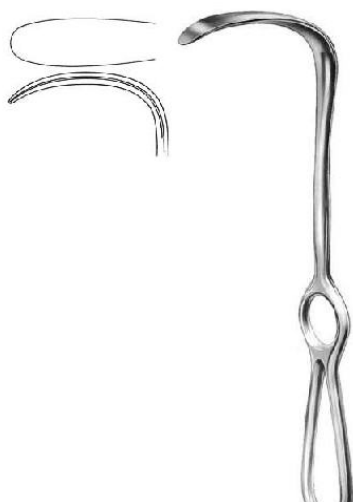

Langenbeck
AS-5-942-21
Retractor
21 cm 65 x 20 mm,

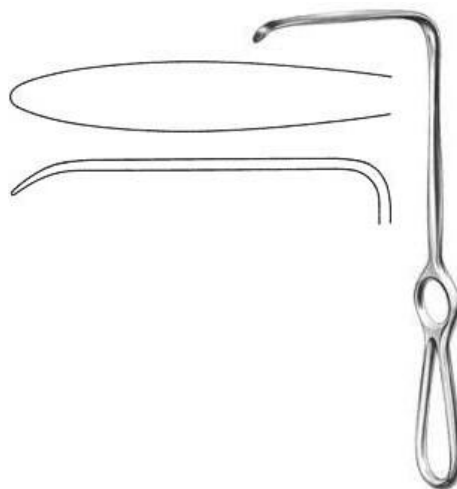

Langenbeck
AS-5-943-21
Retractor
22.5 cm 85 x 15 mm,



Lahey
AS-5-944-19
Retractor
19.5 cm 36 x 19 mm,

SURGICAL INSTRUMENTS

RETRACTORS



Little
AS-5-945-20
Retractor
20 cm 13 x 15 mm,



Kocher
AS-5-946-18
Retractor
23 cm 43 x 18 mm, 23 cm 53 x 20 mm, 23 cm 63 x 25 mm, 23 cm 77 x 30 mm, 23 cm 78 x 40 mm,

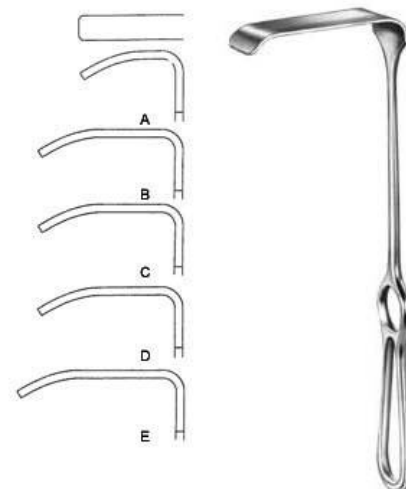

Kocher-Langenbeck
AS-5-947-01
Retractor
21.5 cm 25 x 6 mm, 21.5 cm 35 x 8 mm, 21.5 cm 35 x 11 mm, 21.5 cm 35 x 15 mm, 21.5 cm 40 x 11 mm, 21.5 cm 55 x 11 mm, 21.5 cm 70 x 14 mm, 21.5 cm 80 x 12 mm,

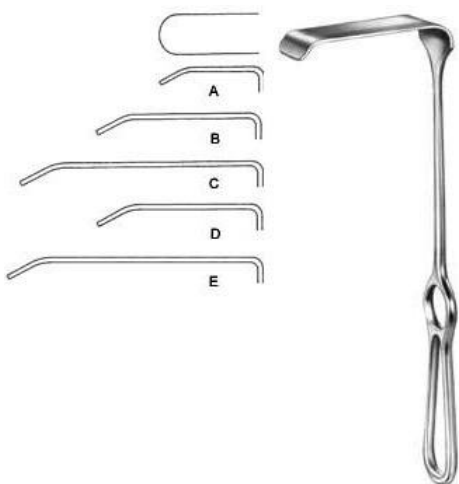

Kocher-Langenbeck
AS-5-948-01
Retractor
21.5 cm 25 x 10 mm, 21.5 cm 40 x 13 mm, 21.5 cm 60 x 13 mm, 21.5 cm 40 x 18 mm, 21.5 cm 60 x 18 mm, 21.5 cm 85 x 18 mm, 21.5 cm 60 x 25 mm, 21.5 cm 85 x 25 mm,

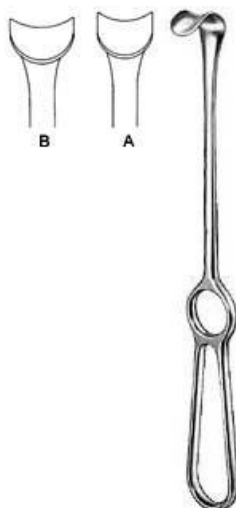

Kocher
AS-5-949-01
Retractor
21.5 cm 22 x 12 mm, 21.5 cm 24 x 14 mm,

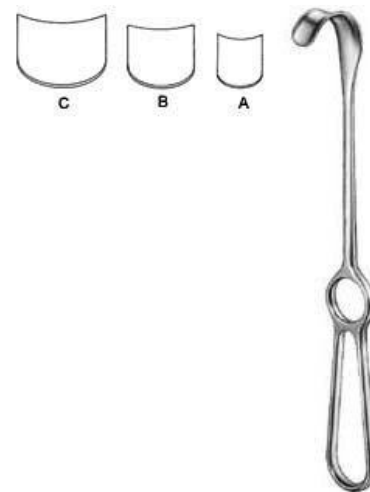

Kocher
AS-5-950-01
Retractor
22 cm 42 x 10 mm, 22 cm 42 x 15 mm, 22 cm 43 x 20 mm,

SURGICAL INSTRUMENTS

RETRACTORS

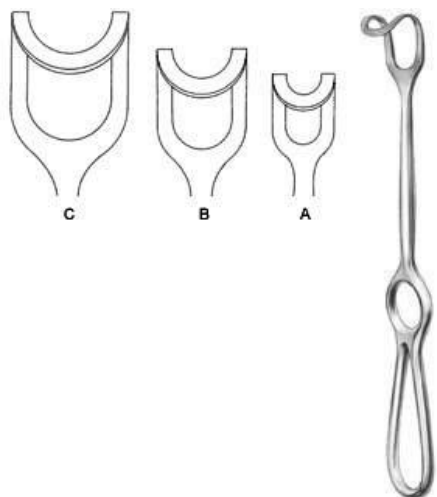

Middeldorpf
AS-5-951-01

Retractor

21.5 cm 18 x 17 mm, 23 cm 25 x 22 mm, 24.5 cm 30 x 31 mm,

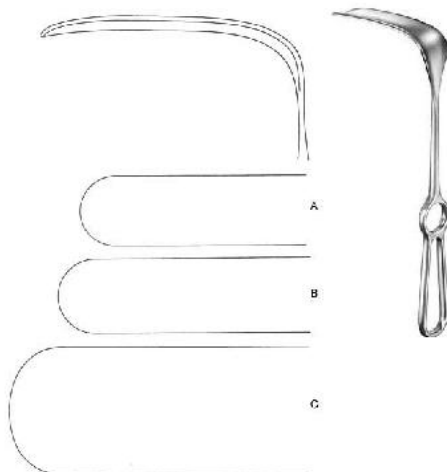

Doyen-Stille
AS-5-952-01

Retractor

26 cm 97 x 29 mm, 26 cm 101 x 31 mm, 26 cm 127 x 52 mm,

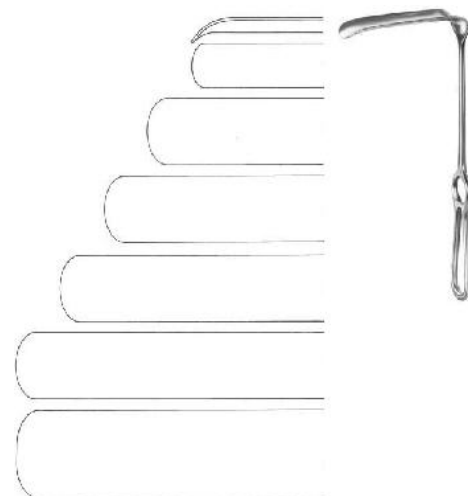

Hosel
AS-5-953-01

Retractor

26 cm 63 x 21 mm, 26 cm 83 x 30 mm, 26 cm 103 x 30 mm, 26 cm 120 x 30 mm, 26 cm 140 x 30 mm, 26 cm 140 x 40 mm,

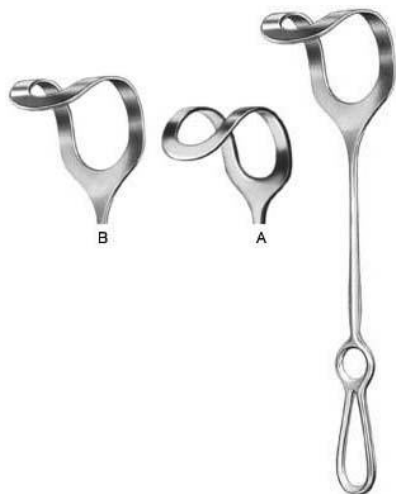

Middeldorpf
AS-5-954-01

Retractor

27 cm 48 x 45 mm, 27 cm 52 x 50 mm, 27 cm 60 x 70 mm,

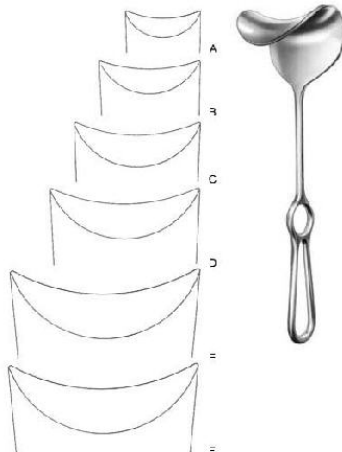

Fritsch
AS-5-955-00

Retractor

23.5 cm 37 x 31 mm, 24 cm 38 x 40 mm, 25 cm 43 x 51 mm, 25 cm 49 x 61 mm, 25.5 cm 48 x 75 mm, 25.5 cm 65 x 85 mm,



Doyen
AS-5-956-25

Retractor

24 cm 48 x 88 mm,

SURGICAL INSTRUMENTS

RETRACTORS



Kocher
AS-5-957-22
Retractor
24 cm 73 x 25 mm,



Kocher
AS-5-958-01
Retractor
25 cm 80 x 45 mm, 25 cm 80 x 55 mm, 25 cm
80 x 65 mm,



Martin
AS-5-959-25
Retractor
26 cm 110 x 27 mm,

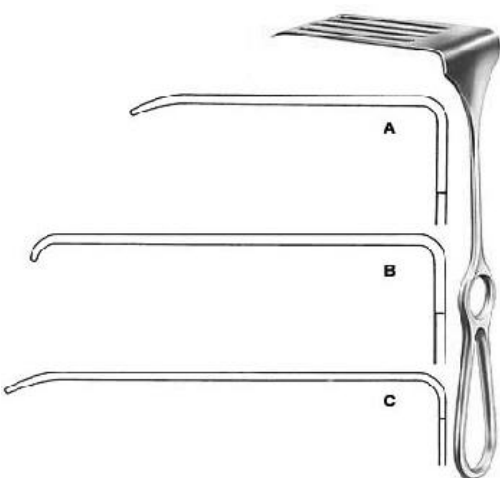

Coryllos
AS-5-960-01
Retractor
24 cm 85 x 22 mm, 24 cm 108 x 43 mm, 24
cm 119 x 65 mm,



Davidson
AS-5-961-01
Retractor
19 cm 80 x 54 mm, 18.5 cm 80 x 95 mm,

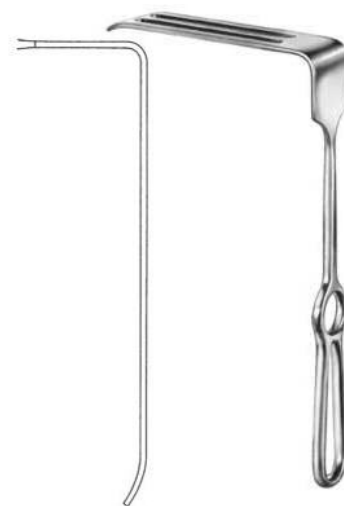

Sauerbruch
AS-5-962-25
Retractor
25.5 cm 127 x 38 mm,

SURGICAL INSTRUMENTS

RETRACTORS

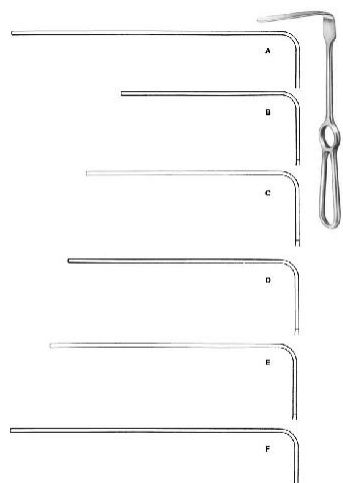

Brunner
AS-5-963-08

Retractor

25.5 cm 84 x 20 mm, 25.5 cm 104 x 25 mm, 25.5 cm 124 x 30 mm, 25.5 cm 130 x 30 mm, 25.5 cm 144 x 30 mm, 25.5 cm 160 x 30 mm, 25.5 cm 164 x 30 mm,

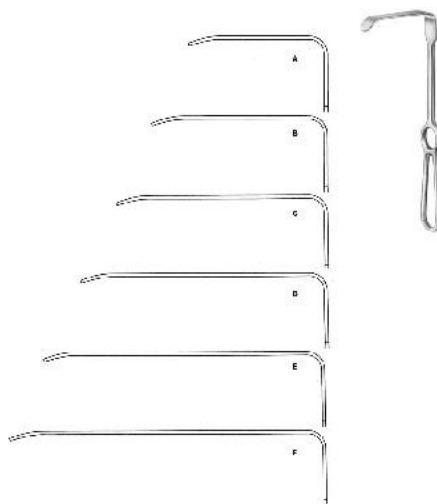

Brunner
AS-5-964-08

Retractor

25.5 cm 82 x 20 mm, 25.5 cm 102 x 20 mm, 25.5 cm 122 x 25 mm, 25.5 cm 140 x 25 mm, 25.5 cm 162 x 30 mm, 25.5 cm 182 x 30 mm,

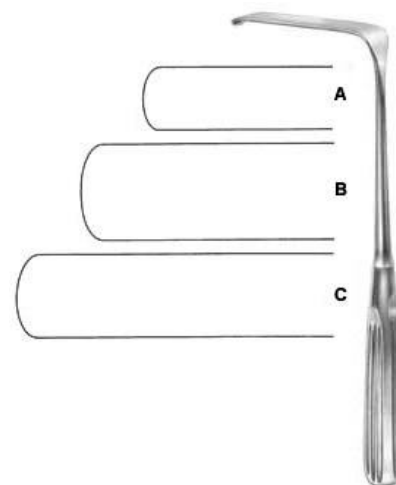

Sauerbruch
AS-5-965-01

Retractor

22.5 cm 50 x 15mm, 22.5 cm 63 x 23mm, 22.5 cm 80 x 20mm,



Deaver
AS-5-966-01

Retractor

18 cm 19mm,

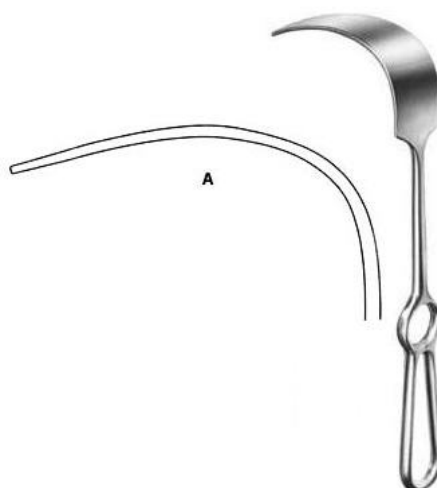

Mikulicz
AS-5-968-01

Retractor

25 cm 90 x 35mm, 25 cm 125 x 50mm, 25 cm 160 x 50mm,

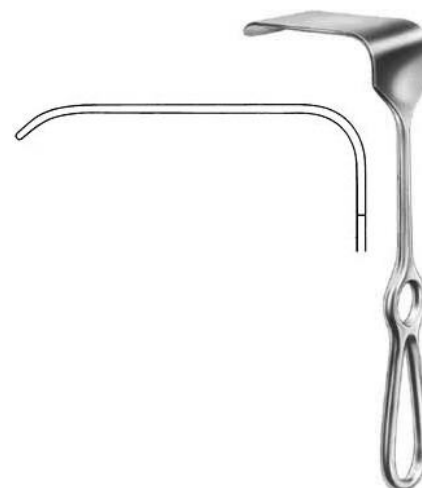

Mikulicz
AS-5-969-26

Retractor

26 cm 90 x 55mm,

SURGICAL INSTRUMENTS

RETRACTORS

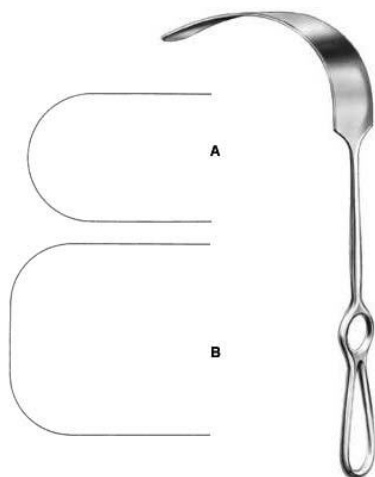

Kelly
AS-5-970-01
Retractor
27.5 cm 205 x 38mm, 27.5 cm 205 x 57mm,



Farabeuf
AS-5-971-00
Retractor
15 cm Fig. 1 = 23 x 16, 15 cm Fig. 1 = 26 x 16, 15 cm Fig. 2 = 27 x 16, 15 cm Fig. 2 = 30 x 16,

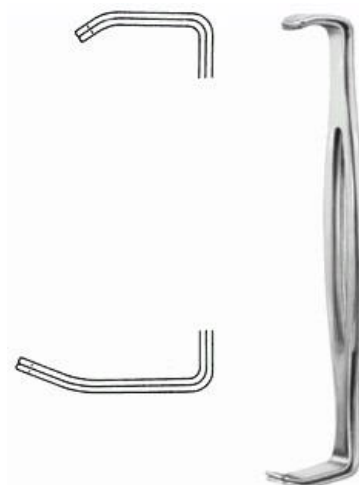

Parker-Langenbeck
AS-5-972-00
Retractor
21.5 cm Fig. 1 = 21x15mm, 21.5 cm Fig. 1 = 40x15mm, 21.5 cm Fig. 2 = 25x15mm, 21.5 cm Fig. 2 = 45x15mm,



Alm
AS-5-973-07
Wound Spreaders, self-retaining
7 cm,



Alm
AS-5-974-07
Wound Spreaders, self-retaining
7 cm,



Gosset
AS-5-975-22
Abdominal Retractor
18.5 cm,

SURGICAL INSTRUMENTS

RETRACTORS



Balfour-Baby
AS-5-976-00

Abdominal Retractor spreading 90mm, 1
central blade 24 x 20mm
12.5 cm,



Balfour
AS-5-977-00

Abdominal Retractor spreading 180mm,
lateral blades 70 x 35mm, 1 central blade
20 cm,

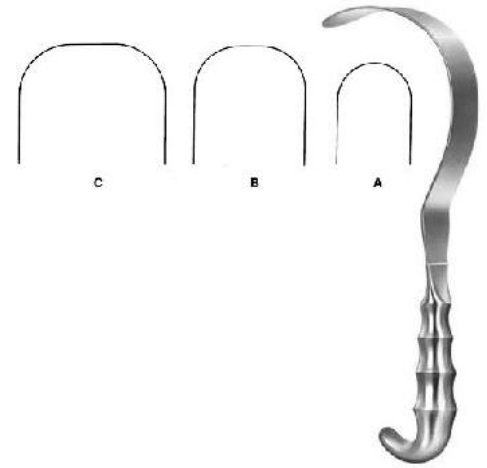

Deaver
AS-5-967-04

Retractor
31.5 cm 25mm, 31.5 cm 38mm, 31.5 cm
50mm, 31.5 cm 100mm,

SURGICAL INSTRUMENTS

CLOWARD RETRACTOR



Cloward Retractor
AS-1101
Cloward Retractor



Cloward Retractor
AS-1102
Cloward Retractor



Cloward Retractor
AS-1103
Cloward Retractor



Cloward Retractor
AS-1104
Cloward Retractor



Cloward Retractor
AS-1105
Cloward Retractor

SURGICAL INSTRUMENTS

COLIN RETRACTOR



colin retractor
AS-1201
colin retractor



colin retractor
AS-1202
colin retractor

SURGICAL INSTRUMENTS

GELPI RETRACTOR



Gelpi Retractor
AS-1301
Gelpi Retractor



Gelpi Retractor
AS-1302
Gelpi Retractor



Gelpi Retractor
AS-1303
Gelpi Retractor



Gelpi Retractor
AS-1304
Gelpi Retractor

SURGICAL INSTRUMENTS

INGE RETRACTOR



Inge Retractor
AS-1401
Inge Retractor



Inge Retractor
AS-1402
Inge Retractor



Inge Retractor
AS-1403
Inge Retractor

SURGICAL INSTRUMENTS

JANSEN RETRACTOR



Jansen Retractor
AS-1501
Jansen Retractor



Jansen Retractor
AS-1502
Jansen Retractor

SURGICAL INSTRUMENTS

MOLLISON RETRACTOR

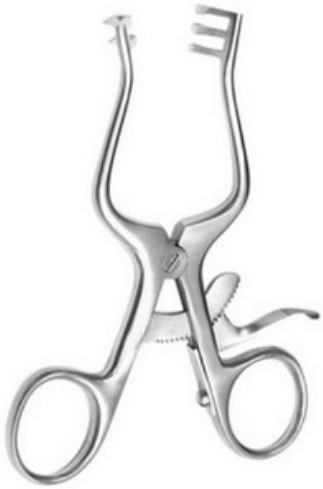

Mollison Retractor
AS-1601
Mollison Retractor



Mollison Retractor
AS-1602
Mollison Retractor



Mollison Retractor
AS-1603
Mollison Retractor

SURGICAL INSTRUMENTS

SELF RETAINING



self retaining
AS-1701
self retaining



self retaining
AS-1702
self retaining



self retaining
AS-1703
self retaining



self retaining
AS-1704
self retaining

SURGICAL INSTRUMENTS

WEITLANER RETRACTOR



Weitlaner Retractor
AS-1801
Weitlaner Retractor



Weitlaner Retractor
AS-1802
Weitlaner Retractor



Weitlaner Retractor
AS-1803
Weitlaner Retractor

SURGICAL INSTRUMENTS

ABDOMINAL RETRACTOR



Abdominal Retractor
AS-1901
Abdominal Retractor



Abdominal Retractor
AS-1902
Abdominal Retractor



Abdominal Retractor
AS-1903
Abdominal Retractor

SURGICAL INSTRUMENTS

BECKMAN RETRACTOR



Beckman retractor
AS-2001
Beckman retractor



Beckman retractor
AS-2002
Beckman retractor



Beckman retractor
AS-2003
Beckman retractor

SURGICAL INSTRUMENTS

ADSON RETRACTOR



Adson Retractor
AS-2101
Adson Retractor



Adson Retractor
AS-2102
Adson Retractor



Adson Retractor
AS-2103

SURGICAL INSTRUMENTS

ALM RETRACTOR



Alm Retractor
AS-2201
Alm Retractor



Alm Retractor
AS-2202

SURGICAL INSTRUMENTS

BALFOUR RETRACTOR



Balfour Retractor
AS-2301
Balfour Retractor

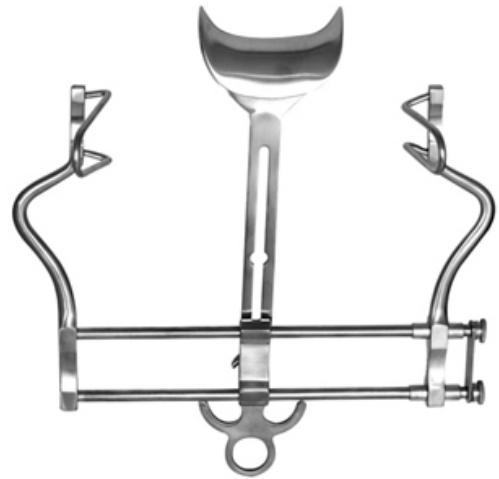

Balfour Retractor
AS-2302
Balfour Retractor

SURGICAL INSTRUMENTS

DIAGNOSTICS



Buck
AS-1-101-18
Percussion Hammer
18.5 cm,



Buck
AS-1-102-18
Percussion Hammer
20cm,



Dejerine
AS-1-103-20
Percussion Hammer
20cm,



Dejerine
AS-1-104-21
Percussion Hammer
21cm,



Taylor Mod. USA
AS-1-105-20
Percussion Hammer
20cm,



Wartenberg
AS-1-106-19
Pinwheel
18cm,

SURGICAL INSTRUMENTS

DIAGNOSTICS



Pinard
AS-1-107-18
Stethoscope
18 cm,



Pinard
AS-1-108-15
Stethoscope
15cm,

SURGICAL INSTRUMENTS

ANESTHESIA



Magill
AS-2-101-15
Catheter Introducing Forceps
14.5 cm, 20 cm, 25 cm,



Miller
AS-2-102-00
Laryngoscope Sets



Miller-Baby
AS-2-103-00
Laryngoscope Sets



Miller
AS-2-104-00
Laryngoscope Blade
Fig. 0, Fig. 1, Fig. 2, Fig. 3, Fig. 4,



Guedel-Negus
AS-2-105-00
Laryngoscope Sets
Fig. 2, Fig. 3, Fig. 4,



Guedel-Negus
AS-2-106-00
Laryngoscope Sets
Fig. 1, Fig. 2, Fig. 3, Fig. 4,

SURGICAL INSTRUMENTS

ANESTHESIA



Guedel-Negus
AS-2-107-01

Laryngoscope Blades
Fig. 1, Fig. 2, Fig. 3, Fig. 4,



McIntosh
AS-2-108-00



McIntosh
AS-2-109-00

Laryngoscope Blades
Fig. 0, Fig. 1, Fig. 2, Fig. 3, Fig. 4,



McIntosh
AS-2-110-00

Laryngoscope Sets
Fig. 1, Fig. 2, Fig. 3, Fig. 4,



Foregger
AS-2-111-01

Laryngoscope Blades
Fig. 1, Fig. 2, Fig. 3, Fig. 4,



Battery Handle
AS-2-112-00

Battery Handle

SURGICAL INSTRUMENTS

ANESTHESIA



McIntosh

AS-2-114-00

Laryngoscope Sets fiber optic
Fig. 1, Fig. 2, Fig. 3,



McIntosh

AS-2-115-00

Laryngoscope Sets fiber optic
Fig. 1, Fig. 2, Fig. 3,



McIntosh

AS-2-116-00

Laryngoscope Sets fiber optic
Fig. 1, Fig. 2, Fig. 3,



McIntosh

AS-2-113-00

Laryngoscope Sets
Fig. 1, Fig. 2, Fig. 3, Fig. 4,

SURGICAL INSTRUMENTS

TROCARS



Universal
AS-3-101-04
Trocar
14 cm,



Nelson
AS-3-102-07
Trocar
20 cm,



Lichtwitz
AS-3-103-19
Antrum Trocar
18.5 cm,



Adson
AS-3-104-21
Suction Cannula
20 cm,



Frazier
AS-3-105-10
Suction Cannula
24 cm,



Frazier
AS-3-106-06
Suction Cannula
19.5 cm,

SURGICAL INSTRUMENTS

TROCARS



Poppen
AS-3-107-06
Suction Cannula
18 cm,



Luer
AS-3-108-30
Suction Tube working length 110 mm



Yasargil
AS-3-109-15
Suction Tube working length 150 mm with
Luer hub
21.5 cm,



Yankauer
AS-3-110-27
Suction Tube complete with suction tip and
connector
31 cm,



Yankauer
AS-3-111-00
Suction Tube
31 cm, 15 cm, 2.5 cm, 10 cm,



Poole
AS-3-112-22
Suction Tube
22 cm,

SURGICAL INSTRUMENTS

TROCARS



Pooler
AS-3-113-22
Suction Tube
22.5 cm,



Nuboer
AS-3-114-21
Suction Tube
21 cm,



Nuboer
AS-3-115-21
Suction Tube
21 cm,



Quinke
AS-3-116-10
Lumbar Puncture Needle



Tuohy
AS-3-117-12
Lumbar Puncture Needle Luer Lock
connection with special tip



Verres
AS-3-118-20
Insufflation Cannula Luer Lock connection
15 cm,

SURGICAL INSTRUMENTS

TROCARS



Verres

AS-3-119-20

Insufflation Cannula Luer Lock connection
17 cm,

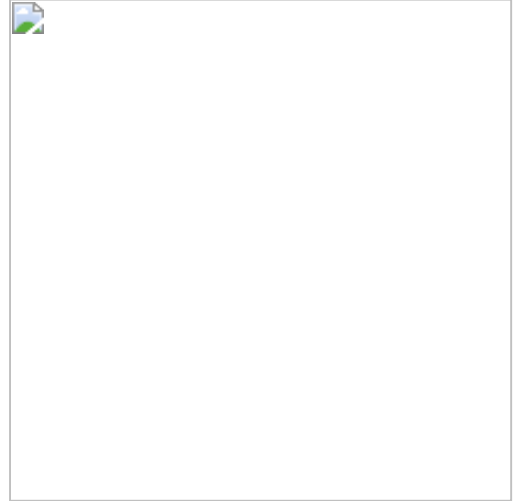

Taka Suction Tube

AS-3-108-08

 FUKUSHIMA TAPERED SUCTION
TUBES
100mm Total length, 120mm, 145mm, 160mm,

SURGICAL INSTRUMENTS

SUTURE



Kalt
AS-4-105-14
Needle Holder
13.5 cm,



Barraquer-Troutman
AS-4-106-10
Micro Needle Holder
10 cm, 10.5 cm,



Arruga
AS-4-107-14
Micro Needle Holder
13.5 cm,



Barraquer-Troutman
AS-4-108-10
Micro Needle Holder
10.5 cm, 11.5 cm,



Barraquer
AS-4-109-11
Micro Needle Holder
11.5 cm, 13.5 cm, 14 cm,



Barraquer
AS-4-110-13
Micro Needle Holder
13.5 cm,

SURGICAL INSTRUMENTS

SUTURE



Castroviejo-Fino
AS-4-111-01
Micro Needle Holder
13 cm,



Castroviejo-Fino
AS-4-112-01
Micro Needle Holder
13 cm,



Castroviejo-Fino
AS-4-113-01
very delicate jaw with lock
13 cm,



Castroviejo
AS-4-114-14
Micro Needle Holder with lock
14 cm,



Castroviejo
AS-4-115-14
Micro Needle Holder
14 cm,



Castroviejo
AS-4-121-14
Micro Needle Holder with lock
14 cm,

SURGICAL INSTRUMENTS

SUTURE



Castroviejo
AS-4-122-14
Micro Needle Holder
14 cm,



Castroviejo
AS-4-124-13
Micro Needle Holder with lock
12 cm,



Arruga
AS-4-123-16
Needle Holder delicate
16 cm,



Castroviejo
AS-4-125-12
Micro Needle Holder with lock
12 cm,



Derf
AS-4-126-12
Needle Holder
12 cm, 13 cm,

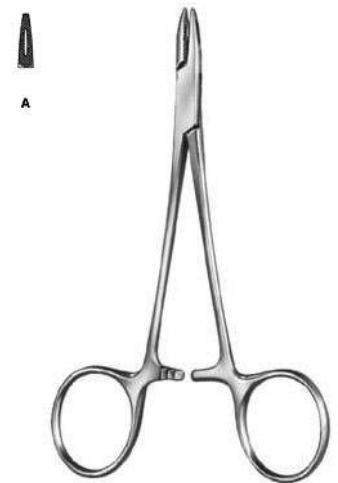

Collier
AS-4-127-12
Needle Holder
12.5 cm,

SURGICAL INSTRUMENTS

SUTURE

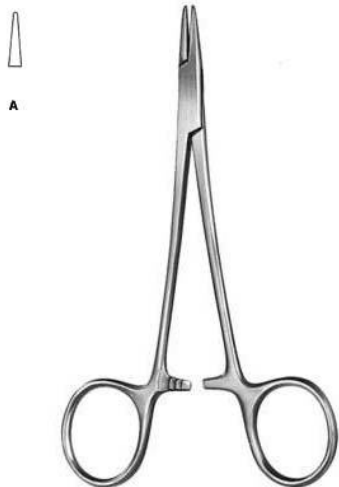

Webster
AS-4-128-13
Needle Holder
13 cm,

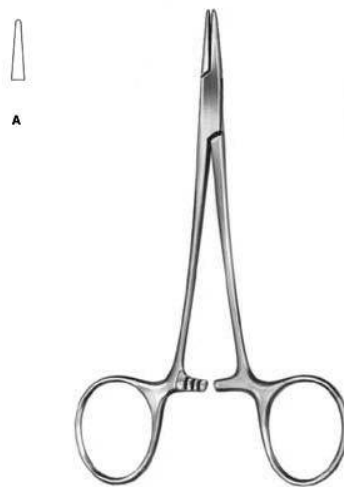

Halsey
AS-4-129-13
Needle Holder
13.5 cm,



Neivert
AS-4-130-13
Needle Holder
12.5 cm,

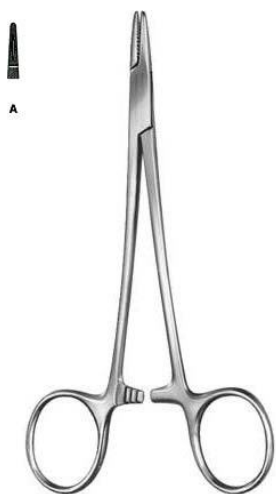

Hegar-Baumgartner
AS-4-131-14
Needle Holder
14.5 cm,



Crile-Murray
AS-4-133-15
Needle Holder
15 cm,



Crile-Wood
AS-4-134-15
Needle Holder
15 cm,

SURGICAL INSTRUMENTS

SUTURE



Adson

AS-4-140-18

Needle Holder one fenestrated jaw
18 cm,



Metzenbaum

AS-4-141-18

Needle Holder one grooved and fenestrated
jaw
18.5 cm,



M. G. Hospital

AS-4-142-17

Needle Holder
17.5 cm,



Mayo-Hegar

AS-4-143-14

Needle Holder

14.5 cm, 16 cm, 18.5 cm, 20.5 cm, 24 cm, 26.5
cm,



Mayo-Hegar

AS-4-144-16

Needle Holder

16 cm, 18.5 cm, 20.5 cm,



Brown

AS-4-145-13

Needle Holder

13 cm, 18 cm,

SURGICAL INSTRUMENTS

SUTURE

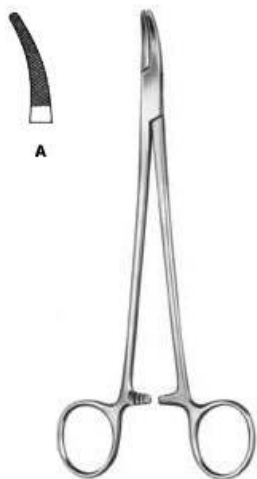

Heaney
AS-4-146-21
Needle Holder
20.5 cm,

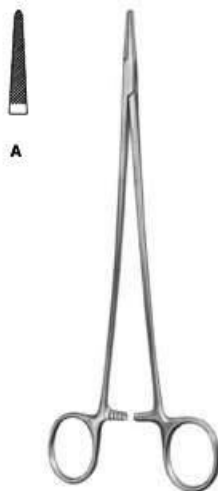

Jamison
AS-4-147-23
Needle Holder
23.5 cm,



Masson
AS-4-148-27
Needle Holder
26.5 cm,

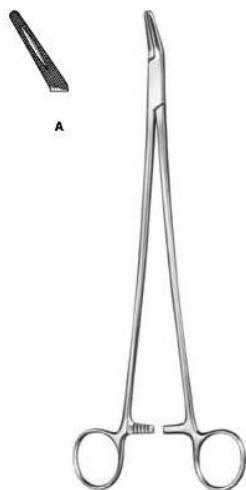

Finochietto
AS-4-149-27
Needle Holder
26.5 cm,



Wangensteen
AS-4-150-27
Needle Holder
26.5 cm,

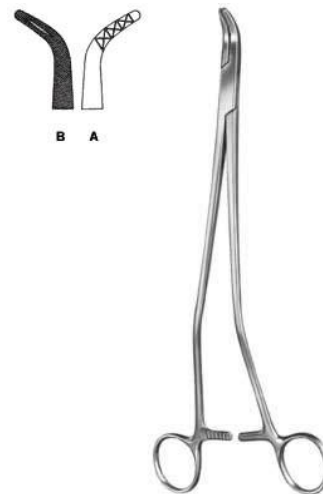

Johnson
AS-4-151-27
Needle Holder
27 cm,

SURGICAL INSTRUMENTS

SUTURE

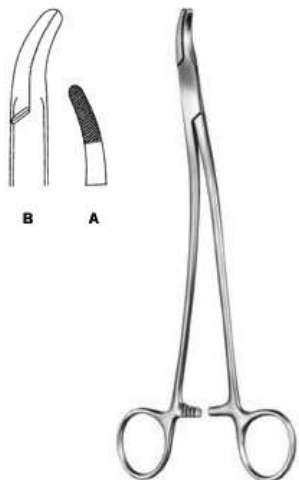

Stratte
AS-4-152-23
Needle Holder
23 cm,

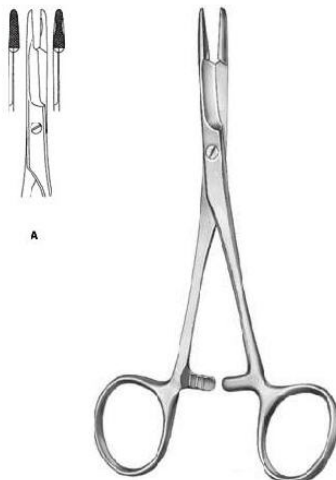

Olsen-Hegar
AS-4-153-14
Needle Holder
14 cm,

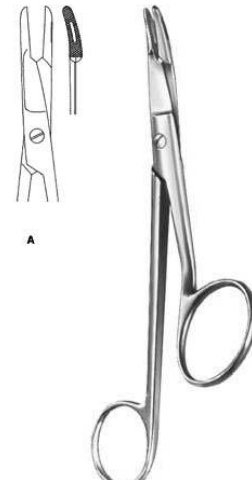

Gillies
AS-4-154-16
Needle Holder
16 cm,



Crile
AS-4-155-15
Needle Holder
15 cm,



Mathieu
AS-4-156-14
Needle Holder
14 cm, 17 cm, 20 cm,



Mathieu
AS-4-157-14
Needle Holder
14 cm, 16.5 cm,

SURGICAL INSTRUMENTS

SUTURE



Toennis
AS-4-158-18
Needle Holder
18.5 cm,



Lichtenberg
AS-4-159-20
Needle Holder
20 cm,



AS-4-160-16
Micro Needle Holder
16 cm,

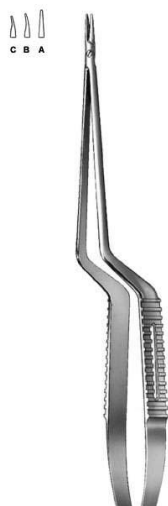

AS-4-161
Micro Needle Holder
23 cm, 19 cm,



Hepp-Scheidel
AS-4-162-18
Micro Needle Holder smooth jaw
18 cm,



Webster
AS-4-163-13
Needle Holder with automatic release ratchet
also for lefthanders
13 cm, 15 cm,

SURGICAL INSTRUMENTS

SUTURE



AS-4-164-15
Micro Needle Holder
15 cm, 18 cm, 21 cm, 23 cm,



JABOMA
AS-4-165-18
Micro Needle Holder
18 cm,



Castroviejo
AS-4-166
Micro Needle Holder
14.5 cm, 18 cm, 21.5 cm,



Arruga
AS-4-167
Needle Holder
16 cm,



Castroviejo
AS-4-168-13
Micro Needle Holder
12.5 cm,



Barraquer
AS-4-169-13
Micro Needle Holder
13 cm,

SURGICAL INSTRUMENTS

SUTURE



Barraquer
AS-4-170-13
Micro Needle Holder
13 cm,



Webster
AS-4-171-13
Needle Holder
13 cm,

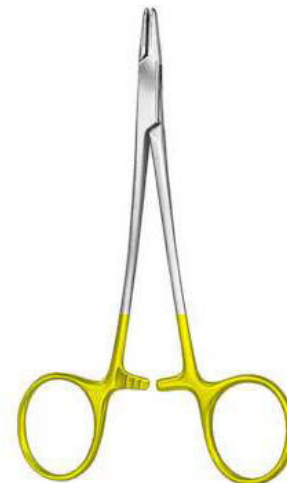

Derf
AS-4-173-12
Needle Holder
12 cm,

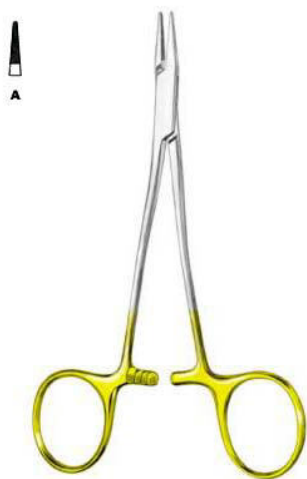

Kilner
AS-4-172-13
Needle Holder
13 cm,



Hegar-Baumgartner
AS-4-174-13
Needle Holder
13 cm, 14.5 cm,



Halsey
AS-4-175-12
Needle Holder
13 cm, 12 cm,

SURGICAL INSTRUMENTS

SUTURE



Crile-Wood
AS-4-176-15
Needle Holder
15 cm,

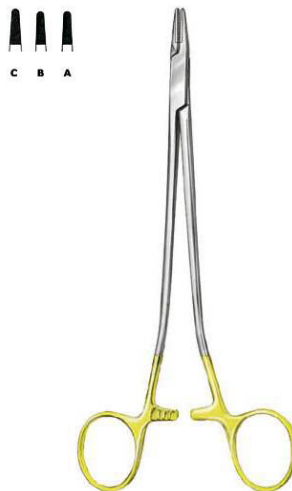

Sarot
AS-4-177-18
Needle Holder
18 cm, 20 cm, 26 cm,

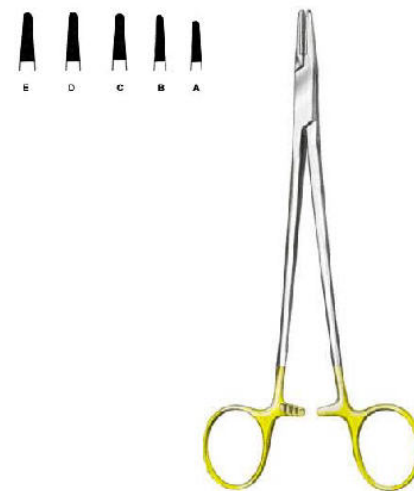

Mayo-Hegar
AS-4-178-16
Needle Holder standard profile
16 cm, 18 cm, 20 cm, 24 cm, 26 cm, 30 cm,



Heaney
AS-4-179-20
Needle Holder
20 cm, 24 cm, 26 cm,



DeBakey
AS-4-180-18
Needle Holder delicate pattern mini profile
18 cm, 20 cm, 23 cm, 26 cm, 31 cm,



Masson
AS-4-181-27
Needle Holder
26.5 cm,

SURGICAL INSTRUMENTS

SUTURE

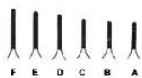

Ryder (Martin)
AS-4-182-13

Needle Holder

12.5 cm, 15 cm, 18 cm, 20 cm, 23 cm, 26 cm,

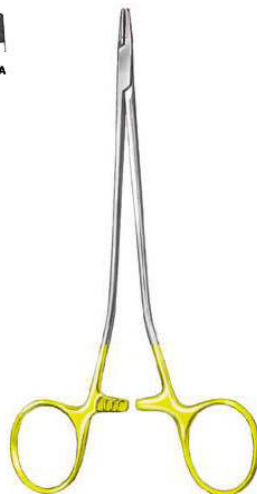

Martin

AS-4-183-15

Needle Holder mini profile elastic type
15 cm, 17 cm, 20 cm,



Wangensteen

AS-4-184-27

Needle Holder standard profile
27 cm,



Hegar-Vascular

AS-4-185-14

Needle Holder micro profile
14 cm, 18.5 cm, 20.5 cm, 23 cm,

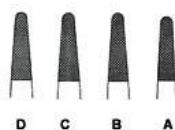

Bozemann

AS-4-186-20

Needle Holder standard profile
20.5 cm, 24 cm, 26.5 cm, 29 cm,



Hegar

AS-4-187-20

Needle Holder standard profile
20 cm, 23.5 cm,

SURGICAL INSTRUMENTS

SUTURE

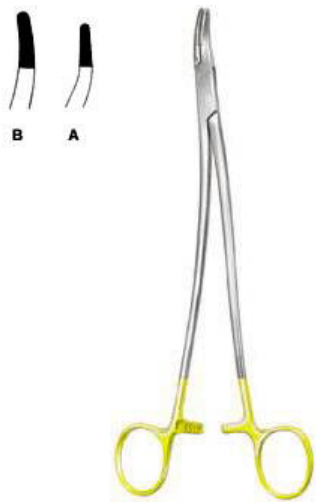

Stratte
AS-4-188-22
Needle Holder standard profile
23 cm,



Microvascular
AS-4-189-00
Needle Holder slender pattern micro profile
14 cm, 17.5 cm, 20 cm, 23 cm,



Mathieu
AS-4-190-14
Needle Holder
14 cm, 17 cm, 20 cm,



Mathieu
AS-4-191-14
Needle Holder
14 cm, 17 cm, 20 cm,



Mathieu
AS-4-192-17
Needle Holder standard profile with interior
ratchet
17 cm, 20 cm, 23 cm,



Toennis
AS-4-193-18
Needle Holder
18.5 cm,

SURGICAL INSTRUMENTS

SUTURE



Lichtenberg
AS-4-194-20

Needle Holder lightweight model standard profile
20 cm,



Langenbeck
AS-4-195-18

Needle Holder
18 cm, 20.5 cm, 23 cm,



Zweifel
AS-4-196-20

Needle Holder with hinged ratchet standard profile
20.5 cm, 23 cm,



Reverdin
AS-4-197-15

Reverdin Needle short
14.5 cm Fig. 1, 14.5 cm Fig. 2, 14.5 cm Fig. 3, 14.5 cm Fig. 4,

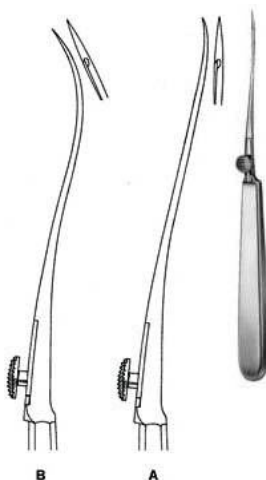

Reverdin
AS-4-198-19

Reverdin Needle medium
19.5 cm Fig. 1, 19.5 cm Fig. 2, 19.5 cm Fig. 3, 19.5 cm Fig. 4,

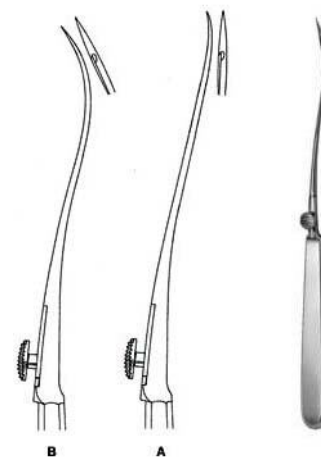

Reverdin
AS-4-199-23

Reverdin Needle long
23 cm Fig. 1, 23 cm Fig. 2, 23 cm Fig. 3, 23 cm Fig. 4,

SURGICAL INSTRUMENTS

SUTURE

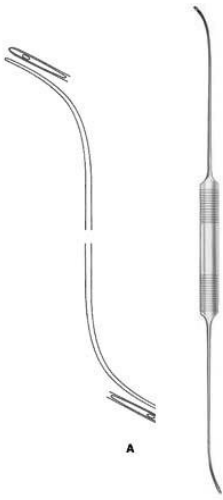

Schmieden-Dick
AS-4-201-01
Ligature Needle malleable
29 cm,

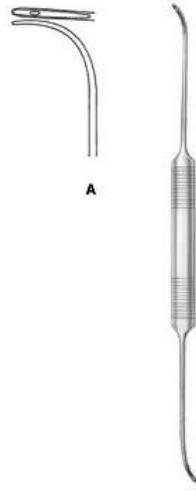

Schmieden
AS-4-202-21
Ligature Needle
24 cm,



AS-4-203-20
Ligature Needle malleable
20.5 cm,

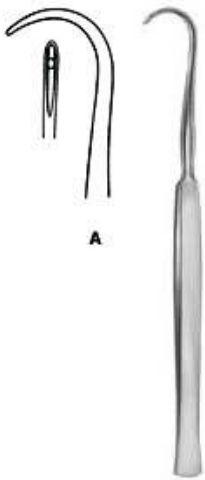

Cooper
AS-4-204-19
Ligature Needle
18.5 cm,



Kronecker
AS-4-205-13
Ligature Needle delicate for right hand
12.5 cm,

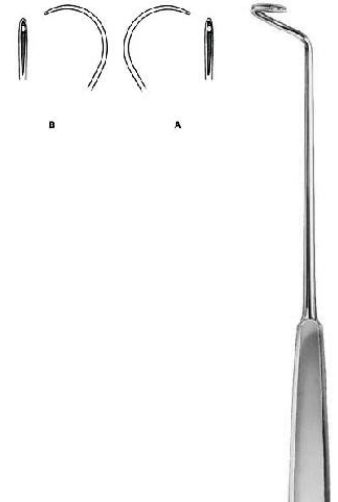

Deschamps
AS-4-206-24
Ligature Needle blunt for right hand
24 cm,

SURGICAL INSTRUMENTS

SUTURE

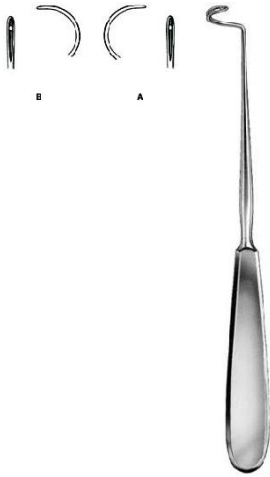

Deschamps
AS-4-207-20

Ligature Needle blunt for right hand
20 cm,



Deschamps
AS-4-208-20

Ligature Needle sharp for right hand
20 cm,

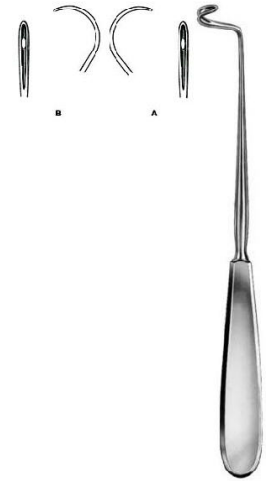

Deschamps
AS-4-209-21

Ligature Needle blunt for right hand
20 cm,

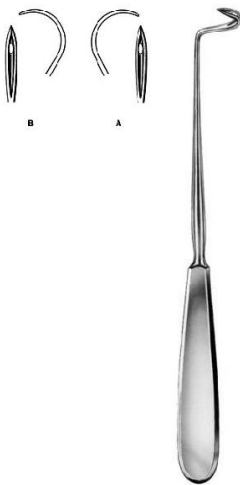

Deschamps
AS-4-210-21

Ligature Needle sharp for right hand
20 cm,

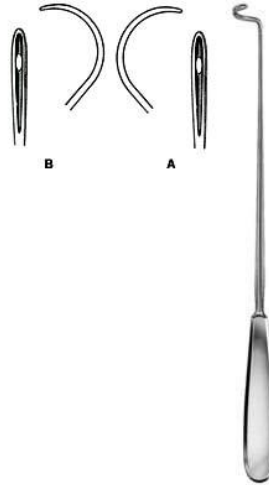

Deschamps
AS-4-211-27

Ligature Needle blunt for right hand
27 cm,

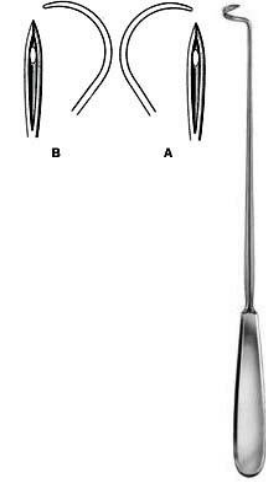

Deschamps
AS-4-212-27

Ligature Needle sharp for right hand
27 cm,

SURGICAL INSTRUMENTS

SUTURE

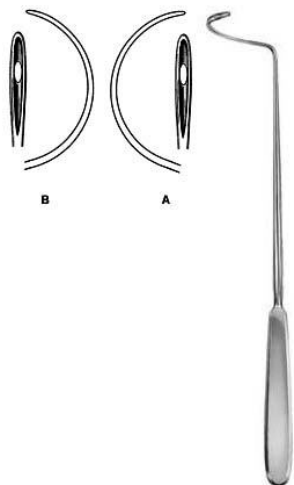

Deschamps
AS-4-213-28

Ligature Needle blunt for right hand
28 cm,

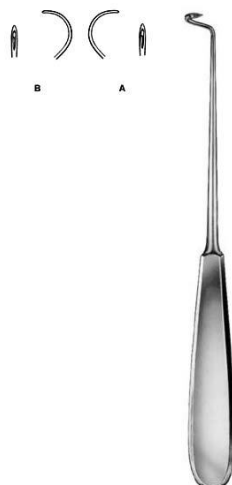

Deschamps
AS-4-214-20

Ligature Needle sharp for right hand
20 cm,



Deschamps
AS-4-215-20

Ligature Needle blunt for right hand
20 cm,



Deschamps
AS-4-216-20

Ligature Needle blunt for right hand
21 cm,

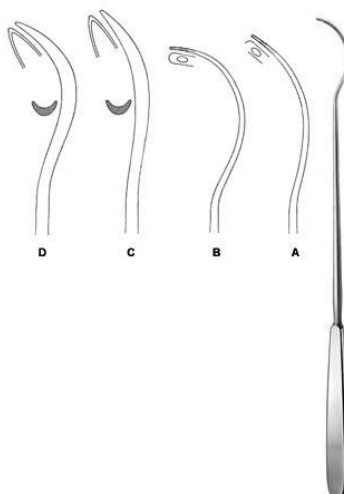

Brunner
AS-4-217-30

Ligature Needle
21 cm,



Kirschner
AS-4-218-25

Ligature Conductor
25.5 cm,

SURGICAL INSTRUMENTS

SUTURE

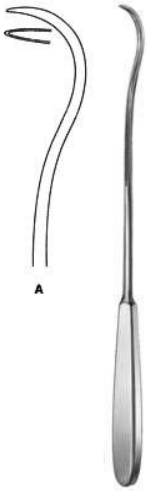

AS-4-219-28
Ligature Conductor
28 cm,



Modell Wien
AS-4-220-23
Ligature Catcher
23.5 cm,



Michel
AS-4-221-12
Clip Applying Forceps
12 cm,



Hegenbarth
AS-4-222-12
Clip Applying Forceps
12 cm,

SURGICAL INSTRUMENTS

SCALPLES



AS-5-101-01

Dissecting Knife with metal handle
15 cm, 15.5 cm, 16 cm, 17 cm,



AS-5-102-10

Autopsy Knife
25.5 cm,

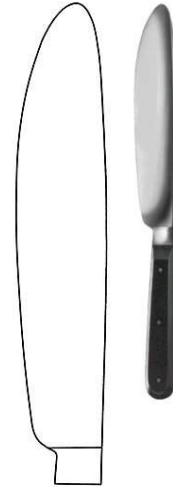

Walb

AS-5-104-17

Post Mortem Knife

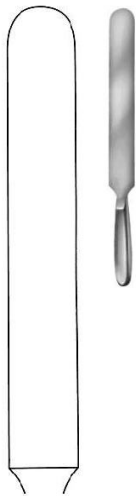

Virchow

AS-5-105-20

Brain Knife with hollow handle
28.5 cm, 33.5 cm, 38 cm,



AS-5-108-04

Scalpel Handle solid
13.5 cm,



AS-5-109-34

Scalpel Handle
16 cm,

SURGICAL INSTRUMENTS

SCALPLES



AS-5-110-41
Scalpel Handle solid, long
21 cm,



AS-5-111-45
Scalpel Handle
21 cm,



Collin
AS-5-112-08
Scalpel Handle with hollow handle
13.5 cm,



Collin
AS-5-113-09
Scalpel Handle with hollow handle
14.5 cm,



AS-5-114-03
Scalpel Handle solid
12 cm,



AS-5-115-04
Scalpel Handle
12 cm,

SURGICAL INSTRUMENTS

SCALPLES



AS-5-116-05
Scalpel Handle
12 cm,



AS-5-117-31
Scalpel Handle solid, long
21.5 cm,

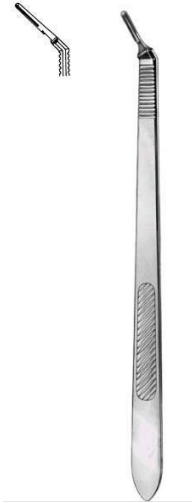

AS-5-118-35
Scalpel Handle
21 cm,



AS-5-119-07
Scalpel Handle solid
16 cm,



AS-5-120-71
Scalpel Handle solid short
12.5 cm,



AS-5-121-03
Scalpel Handle with round hollow handle
15.5 cm,

SURGICAL INSTRUMENTS

SCALPLES



AS-5-127-16

Amputation Knife with hollow handle
29 cm,



AS-5-128-19

Amputation Knife with hollow handle
32.5 cm,



Catlin

AS-5-129-16

Interosseous Knife with hollow handle
29cm,



AS-5-130-06

Resection Knife solid handle, dissecting end
18 cm,



Langenbeck

AS-5-131-05

Resection Knife
18 cm,



Langenbeck

AS-5-132-05

Resection Knife
18 cm,

SURGICAL INSTRUMENTS

SCALPLES



AS-5-133-00

Razor Knife hollow blades on both sides
cutting length 75mm



Schink

AS-5-134-00

Dermatome complete with 2 skin fixing
plates and one blade
31 cm,



Schink

AS-5-135-01

Spare Blade spare blade for KE-05-134-00



Schink

AS-5-136-02

Skin Fixing Plate for KE-05-134-00

SURGICAL INSTRUMENTS

SCISSORS



Standard BL / BL Straight

AS-5-201-13

Operating Scissor Special Price: \$1.25

12 cm, 13 cm, 14.5 cm, 16.5 cm, 18.5 cm, 20.5 cm,



Standard SH / BL STR

AS-5-202-13

Operating Scissors

12 cm, 13 cm, 14.5 cm, 16.5 cm, 18.5 cm, 20.5 cm,



Standard SH / SH STR

AS-5-204-13

Operating Scissors

12 cm, 13 cm, 14.5 cm, 16.5 cm,



Standard BL / BL Curved

AS-5-205-13

Operating Scissors

12 cm, 13 cm, 14.5 cm, 16.5 cm, 18.5 cm, 20.5 cm,



Standard SH / BL Curved

AS-5-206-13

Operating Scissors

12 cm, 13 cm, 14.5 cm, 16.5 cm, 18.5 cm, 20.5 cm,



Standard SH / SH Curved

AS-5-207-13

Operating Scissors

12 cm, 13 cm, 14.5 cm, 16.5 cm,

SURGICAL INSTRUMENTS

SCISSORS



Standard BL / BL Curved
AS-5-208-14
Operating Scissors delicate
14.5 cm,



Incision Scissor
AS-5-209-14
Operating Scissor
14.5 cm,



Deaver
AS-5-210-14
Operating Scissors



Mayo
AS-5-211-15
Dissecting Scissors
14.5 cm, 15 cm, 17 cm, 23.5 cm, 14.5 cm, 15 cm, 17 cm, 23.5 cm,



Mayo
AS-5-212-23
Dissecting Scissors
23 cm, 22.5 cm, 28 cm,



Mayo-Harrington
AS-5-213-22
Dissecting Scissors
23 cm, 22.5 cm, 28 cm,

SURGICAL INSTRUMENTS

SCISSORS

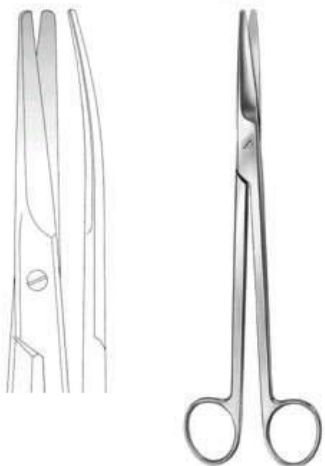

Mayo-Harrington
AS-5-214-22
Dissecting Scissors cur.
22.5 cm, 28 cm, 23 cm,

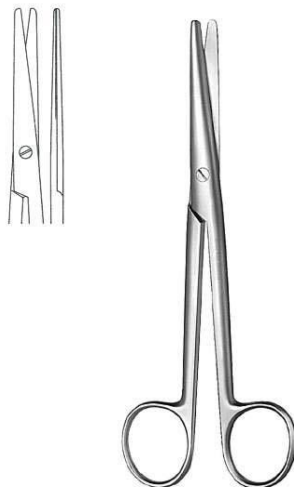

Mayo-Stille
AS-5-215-17
Dissecting Scissors str.
15 cm, 17 cm,

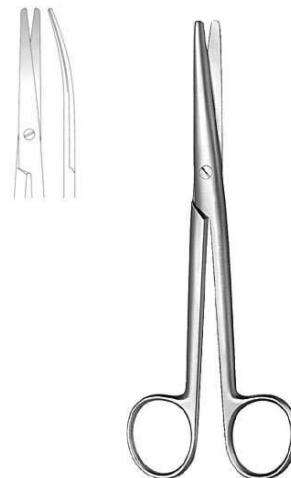

Mayo-Stille
AS-5-216-15
Dissecting Scissors cur.
15 cm, 17 cm,

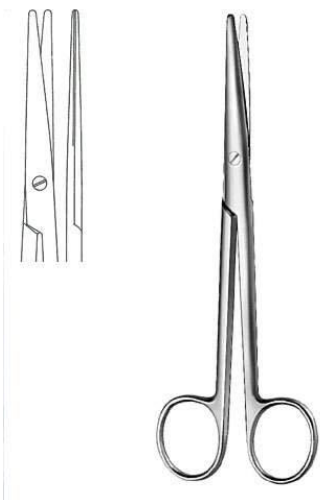

Mayo-Stille
AS-5-217-19
Dissecting Scissors str.
16 cm, 19.5 cm, 21.5 cm,

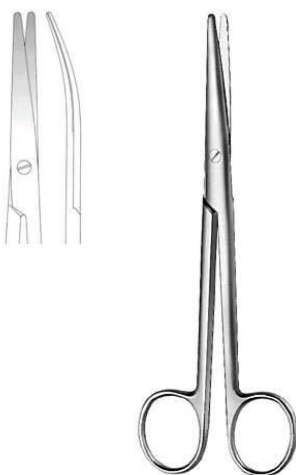

Mayo-Stille
AS-5-218-16
Dissecting Scissors cur.
16 cm, 19.5 cm, 21.5 cm,



Mayo-Noble
AS-5-219-17
Gynecological Scissors
16.5 cm,

SURGICAL INSTRUMENTS

SCISSORS

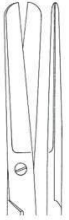

Sims

AS-5-220-23

Gynecological Scissors str.
20 cm, 23 cm,



Sims

AS-5-221-20

Gynecological Scissors cur.
20 cm, 23 cm,



Kelly

AS-5-222-16

Operating Scissors
16 cm,



Doyen

AS-5-223-17

Gynecological Scissors
18.5 cm,



Sims-Siebold

AS-5-224-24

Gynecological Scissors
24.5 cm,



Sims-Siebold

AS-5-225-24

Gynecological Scissors
24.5 cm,

SURGICAL INSTRUMENTS

SCISSORS



Wertheim
AS-5-226-23
Gynecological Scissors
20 cm, 23 cm,



Metzenbaum
AS-5-227-11
Dissecting Scissors
11.5 cm,



Metzenbaum
AS-5-228-14
Dissecting Scissors
14.5 cm,



Metzenbaum
AS-5-229-15
Dissecting Scissors
15.5 cm,



Metzenbaum-Nelson
AS-5-230-20
Dissecting Scissors
18 cm, 20.5 cm, 23 cm, 26 cm, 28.5 cm, 31 cm,



Metzenbaum-Nelson
AS-5-231-20
Dissecting Scissors
18 cm, 20.5 cm,

SURGICAL INSTRUMENTS

SCISSORS



Metzenbaum-Nelson

AS-5-232-20

Dissecting Scissors

18 cm, 20.5 cm, 23 cm, 26 cm, 28.5 cm, 31 cm,



Metzenbaum

AS-5-233-14

Dissecting Scissors toothed

14.5 cm,



Nerve Operating Scissor

AS-5-234-15

Dissecting Scissors

15.5 cm,



Gorney

AS-5-235-19

Face-lift Scissors str.

12.5 cm, 19.5 cm,

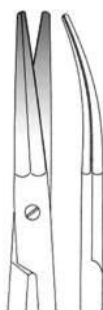

Gorney

AS-5-236-19

Face-lift Scissors cur.

19.5 cm,



Aston

AS-5-237-17

Face-lift Scissors

17 cm,

SURGICAL INSTRUMENTS

SCISSORS



Lexer
AS-5-238-16
Dissecting Scissors
16 cm,



Cinelli
AS-5-239-14
Nasal Scissors
11.5 cm, 14 cm,



Thorek
AS-5-240-19
Dissecting Scissors
18.5 cm,



Lexer-Baby
AS-5-241-10
Dissecting Scissors
10 cm,



Lexer-Fino
AS-5-242-16
Delicate Dissecting Scissors slender pattern
16.5 cm,



Metzenbaum-Fino
AS-5-243-14
Delicate Dissecting Scissors slender pattern
14.5 cm,

SURGICAL INSTRUMENTS

SCISSORS



Metzenbaum-Fino
AS-5-244-14
Delicate Dissecting Scissors
14.5 cm,



Metzenbaum-Fino
AS-5-245-14
Delicate Dissecting Scissors
14.5 cm,



Metzenbaum-Fino
AS-5-246-14
Delicate Dissecting Scissors
14.5 cm,

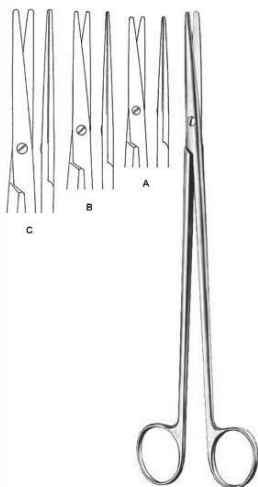

Metzenbaum-Fino
AS-5-247-18
Delicate Dissecting Scissors slender pattern
18 cm, 20 cm, 23 cm,

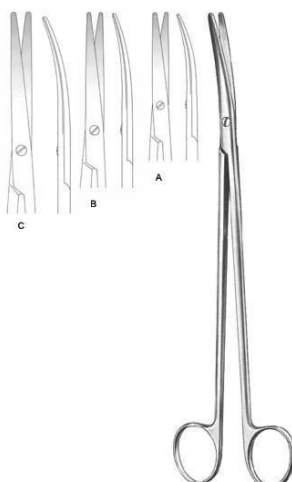

Metzenbaum-Fino
AS-5-248-18
Delicate Dissecting Scissors slender pattern
18 cm, 20 cm, 23 cm,

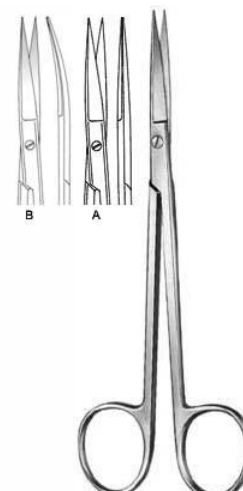

Sanvenero
AS-5-250-14
Operating Scissors
14 cm,

SURGICAL INSTRUMENTS

SCISSORS

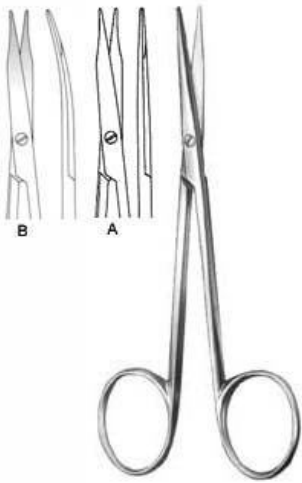

AS-5-251-11
Fine Operating Scissors
11.5 cm,

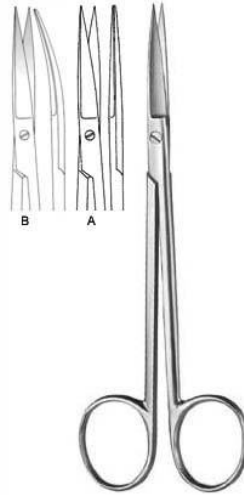

Joseph
AS-5-252-14
Operating Scissors
14.5 cm,

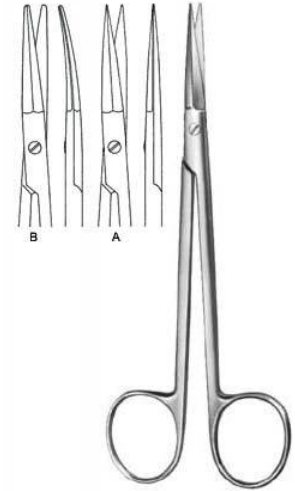

Peck-Joseph
AS-5-253-14
Face-lift Scissors
14.5 cm,

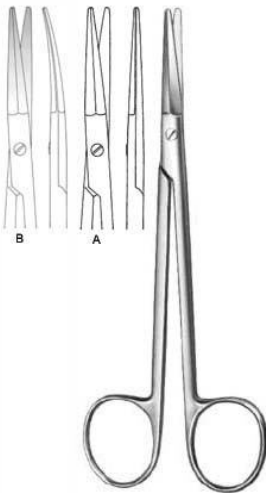

Peck-Joseph
AS-5-254-14
Face-lift Scissors
14.5 cm,



Shea Vein Graft
AS-5-255-12
Dissecting Scissors
12 cm,

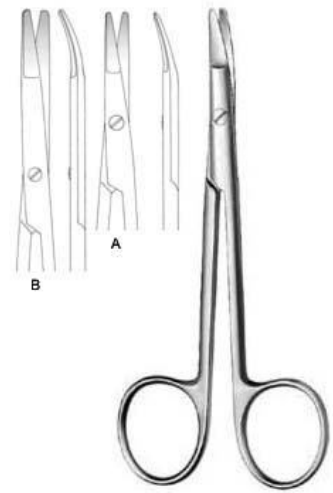

Kilner
AS-5-256-12
Dissecting Scissors
12 cm, 15 cm,

SURGICAL INSTRUMENTS

SCISSORS

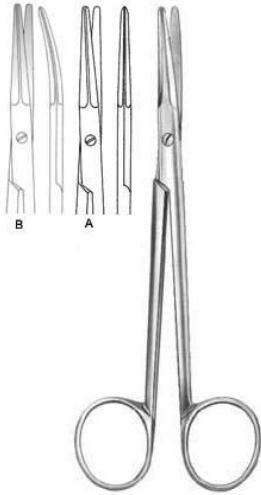

AS-5-257-14
Dissecting Scissors
14.5 cm,

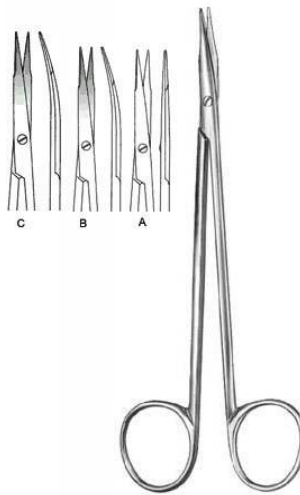

Reynolds
AS-5-258-15
Dissecting Scissors
15.5 cm, 18 cm,



Jameson
AS-5-259-14
Dissecting Scissors
15.5 cm,



Jameson
AS-5-260-14
Dissecting Scissors
15.5 cm,



AS-5-261-19
Vascular Scissors
19 cm,



AS-5-262-24
Vascular Scissors fine, short blades
19 cm, 25.5 cm,

SURGICAL INSTRUMENTS

SCISSORS

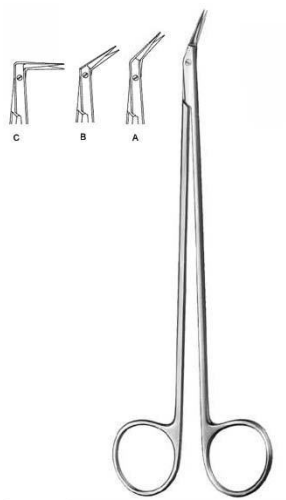

Diethrich
AS-5-263-25
Vascular Scissors
19 cm, 18.5 cm, 17.5 cm,

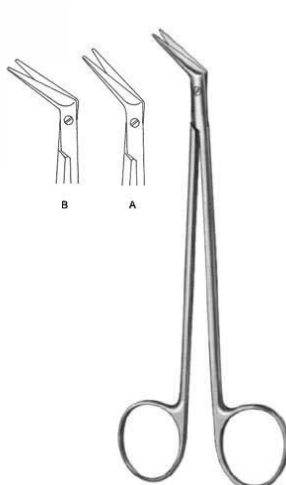

DeBakey
AS-5-264-45
Vascular Scissors
16.5 cm, 16 cm,

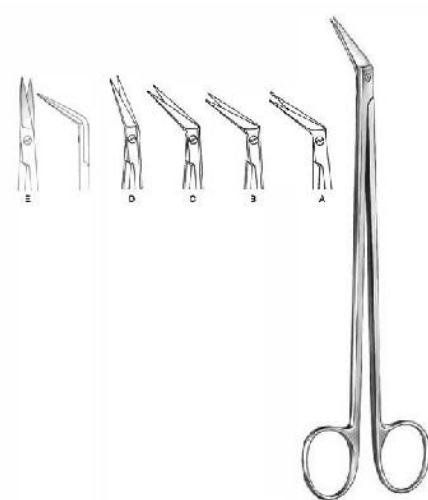

Potts-Smith
AS-5-265-19
Vascular Scissors
18 cm, 18.5 cm, 19 cm,



Coronary Scissors
AS-5-266-25
Cardiovascular Surgery Scissor
18 cm,



Coronary Scissors
AS-5-267-45
Cardiovascular Surgery Scissors
18 cm,



Coronary Scissors
AS-5-268-60
Cardiovascular Surgery Scissor
18 cm,

SURGICAL INSTRUMENTS

SCISSORS



Coronary Scissors
AS-5-269-90
Cardiovascular Surgery Scissor
18 cm,



Coronary Scissors
AS-5-270-00
Cardiovascular Surgery Scissor
18 cm,



Coronary Scissors
AS-5-271-00
Cardiovascular Surgery Scissor
18 cm,



Coronary Scissors
AS-5-272-25
Cardiovascular Surgery Scissor
18 cm,



Coronary Scissors
AS-5-273-45
Cardiovascular Surgery Scissor
18 cm,



Coronary Scissors
AS-5-274-90
Cardiovascular Surgery Scissor
18 cm,

SURGICAL INSTRUMENTS

SCISSORS



Schmieden-Taylor
AS-5-275-17
Dura Scissors
15 cm,



Strully
AS-5-276-22
Neurosurgical Scissors
22.5 cm,



Toennis-Adson
AS-5-277-17
Dissecting Scissors
17.5 cm,



Good
AS-5-279-19
Tonsil Scissors
19.5 cm,



Fomon
AS-5-282-15
Nasal Scissors
15 cm,



Cottle
AS-5-283-16
Nasal Scissors
16 cm,

SURGICAL INSTRUMENTS

SCISSORS



Heymann
AS-5-284-18
Nasal Scissors
18.5 cm,



Heymann
AS-5-285-18
Nasal Scissors
18.5 cm,



Converse
AS-5-286-11
Nasal Scissors blunt & sharp
10.5 cm,



Waldmann
AS-5-287-18
Episiotomy Scissors
18 cm,



Braun-Stadler
AS-5-288-14
Episiotomy Scissors
14.5 cm,



Braun-Stadler
AS-5-289-22
Episiotomy Scissors
22 cm,

SURGICAL INSTRUMENTS

SCISSORS



Modell USA
AS-5-290-10
Umbilical Scissors
10.5 cm,



Busch
AS-5-292-16
Umbilical Scissors
16 cm,



Goldmann-Fox
AS-5-293-13
Gum Scissors
13 cm,



Wagner
AS-5-294-12
Operating Scissors
12 cm,

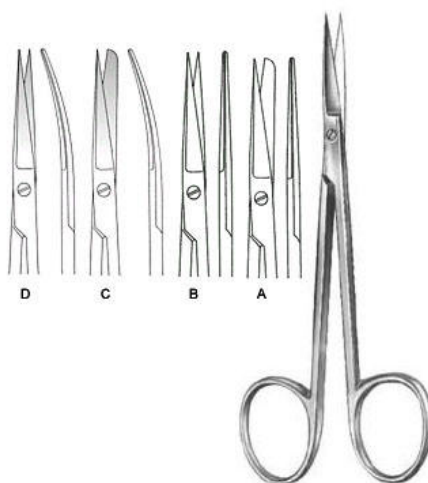

AS-5-295-12
Operating Scissors small model
12 cm,



La Grange
AS-5-296-11
Gum Scissors S-shaped
11.5 cm,

SURGICAL INSTRUMENTS

SCISSORS



AS-5-297-11
Dissecting Scissors delicate
11.5 cm,



Locklin
AS-5-298-16
Gum Scissors
16 cm,



Locklin
AS-5-299-16
Gum Scissors
16 cm,



AS-5-300-08
Operating Scissors very delicate
9 cm,

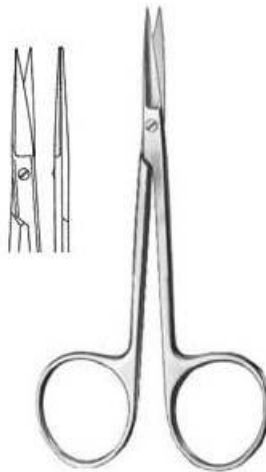

AS-5-301-10
Iris Scissors
9 cm, 10 cm,

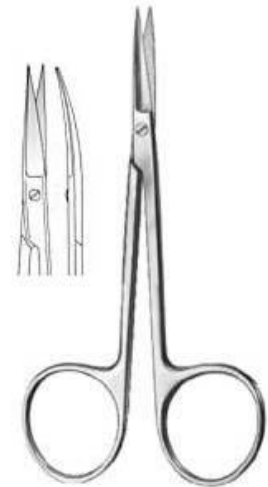

AS-5-302-10
Iris Scissors extra flat blades
10 cm,

SURGICAL INSTRUMENTS

SCISSORS



AS-5-303-10
Iris Scissors extra flat blades
10 cm,



Bonn
AS-5-304-09
Iris Scissors



Dean
AS-5-278-17
Tonsil Scissors
17.5 cm,



Spencer Scissor
AS-0-

SURGICAL INSTRUMENTS

DRESSING & TISSUE FORCEPS



Standard

AS-5-401-10

Dressing Forceps

10.5 cm, 11.5 cm, 13 cm, 14.5 cm, 16 cm, 18 cm, 20 cm, 23 cm, 25 cm, 30.5 cm,



Standard

AS-5-402-11

Dressing Forceps

12 cm, 13 cm, 14.5 cm, 16 cm, 18 cm, 20 cm, 25 cm, 30 cm,



AS-5-403-13

Dressing Forceps

13 cm, 14.5 cm,



Stille

AS-5-404-15

Dressing Forceps

15 cm,



Mini-Adson

AS-5-405-12

Dressing Forceps

12 cm,



Adson

AS-5-406-12

Dressing Forceps

12 cm, 15 cm,

SURGICAL INSTRUMENTS

DRESSING & TISSUE FORCEPS



McIndoe
AS-5-407-15
Dressing Forceps
15 cm,



Waugh
AS-5-408-20
Dressing Forceps
20 cm,



Semken
AS-5-409-12
Dressing Forceps
12.5 cm, 15 cm,



Taylor
AS-5-410-17
Dressing Forceps
12.5 cm, 15 cm,



Taylor
AS-5-411-17
Dressing Forceps
17 cm,



Taylor
AS-5-412-17
Dressing Forceps
18.5 cm,

SURGICAL INSTRUMENTS

DRESSING & TISSUE FORCEPS



AS-5-413-06
Micro Dressing Forceps
15.5 cm,



Gerald
AS-5-414-18
Dressing Forceps
15.5 cm,



Cushing
AS-5-415-17
Dressing Forceps
17.5 cm,



Potts-Smith
AS-5-416-18
Dressing Forceps
18 cm, 21 cm, 24.5 cm,



Bonney
AS-5-417-17
Dissecting Forceps
17.5 cm,



Gerald
AS-5-418-17
Dissecting Forceps
17.5 cm,

SURGICAL INSTRUMENTS

DRESSING & TISSUE FORCEPS



Gillies
AS-5-419-15
Dissecting Forceps
15.5 cm,



McIndoe
AS-5-420-15
Dressing Forceps
15 cm,



Semken
AS-5-421-16
Dissecting Forceps
15.5 cm, 17.5 cm,



Adson-Brown
AS-5-422-12
Dissecting Forceps
12 cm,



Adson
AS-5-423-12
Dissecting Forceps
12 cm, 15 cm,



Adson
AS-5-424-12
Dressing Forceps
12 cm, 15 cm,

SURGICAL INSTRUMENTS

DRESSING & TISSUE FORCEPS



Cushing
AS-5-425-17
Dressing Forceps
17.5 cm,



Cushing
AS-5-426-18
Dressing Forceps
17 cm,



Cushing-Taylor
AS-5-427-18
Dressing Forceps
18.5 cm,



Potts-Smith
AS-5-428-15
Dressing Forceps
16 cm, 18.5 cm, 20 cm, 23 cm, 25 cm,



Oehler
AS-5-429-14
Dissecting Forceps
14.5 cm, 16 cm, 18 cm, 20 cm, 25 cm,



Wangensteen
AS-5-430-15
Dressing Forceps
15 cm, 23 cm,

SURGICAL INSTRUMENTS

DRESSING & TISSUE FORCEPS



DeBakey

AS-5-431-15

Atraumatic Dressing Forceps

16 cm, 20 cm, 24.5 cm, 16 cm, 20 cm, 24.5 cm,



DeBakey

AS-5-432-16

Atraumatic Dressing Forceps

16 cm, 20 cm, 24 cm,

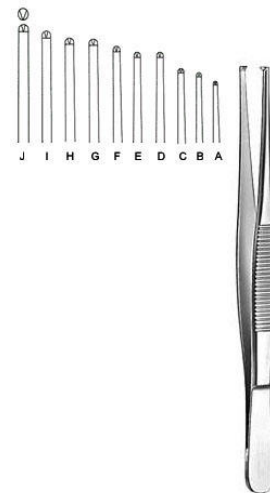

AS-5-433-10

Dissecting Forceps

10.5 cm, 11.5 cm, 13 cm, 14.5 cm, 16 cm, 18 cm, 20 cm, 23 cm, 25 cm, 30.5 cm,

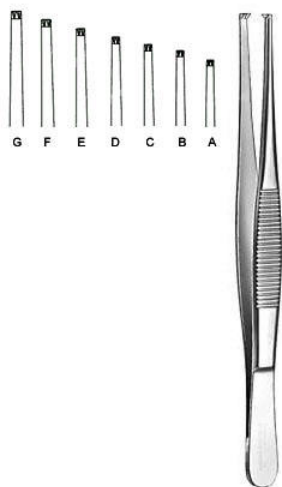

AS-5-434-11

Dissecting Forceps

12 cm, 13 cm, 14.5 cm, 15.5 cm, 18 cm, 20 cm, 24.5 cm,



AS-5-435-14

Dissecting Forceps

14.5 cm, 16 cm,



AS-5-436-14

Dissecting Forceps

14.5 cm, 16 cm,

SURGICAL INSTRUMENTS

DRESSING & TISSUE FORCEPS



AS-5-437-13
Dissecting Forceps
13 cm, 14.5 cm, 16 cm, 20 cm,



AS-5-438-13
Dissecting Forceps
13 cm, 14.5 cm,



Stille
AS-5-439-15
Dissecting Forceps
15 cm,



Stille
AS-5-440-15
Dissecting Forceps
15 cm,



Stone
AS-5-441-15
Dissecting Forceps
15 cm,



Lerche
AS-5-442-15
Dissecting Forceps
15 cm,

SURGICAL INSTRUMENTS

DRESSING & TISSUE FORCEPS

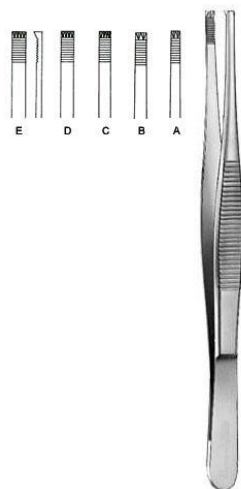

Adlerkreutz
AS-5-443-15

Dissecting Forceps
15.5 cm, 20.5 cm, 16 cm, 20 cm, 25 cm,

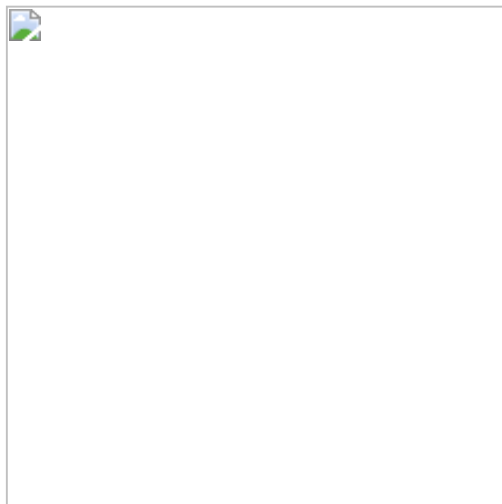

Adson

AS-5-444-12

Dissecting Forceps
12 cm, 15 cm,



Gillies

AS-5-445-15

Dissecting Forceps
15.5 cm,



Waugh

AS-5-446-20

Dissecting Forceps
20.5 cm,



Semken

AS-5-447-12

Dissecting Forceps
12.5 cm, 15 cm,



Taylor

AS-5-448-17

Dissecting Forceps
17.5 cm,

SURGICAL INSTRUMENTS

DRESSING & TISSUE FORCEPS



Taylor
AS-5-449-17
Dissecting Forceps
17 cm,



Taylor
AS-5-450-17
Dissecting Forceps
18.5 cm,



AS-5-451-06
Micro Dissecting Forceps
15.5 cm,



Gerald
AS-5-452-17
Dissecting Forceps
17.5 cm,



Cushing
AS-5-453-17
Dissecting Forceps
18 cm,



Potts-Smith
AS-5-454-18
Dissecting Forceps
18 cm, 21 cm, 24 cm,

SURGICAL INSTRUMENTS

DRESSING & TISSUE FORCEPS

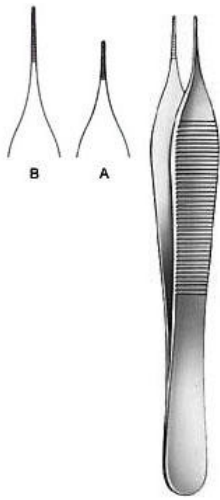

Mikro-Adson
AS-5-455-12
Dressing Forceps
12 cm, 15 cm,

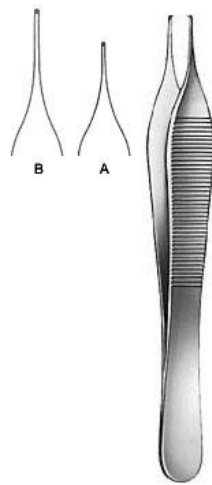

Mikro-Adson
AS-5-456-12
Dissecting Forceps
12 cm, 15 cm,



AS-5-457-11
Dissecting Forceps
10.5 cm,



Micro Jewelers
AS-5-458-12
Jeweler Type Forceps
12 cm Fig. 7,



Jewelers
AS-5-459-12
Jeweler Type Forceps
12 cm Fig. 3,



Jewelers
AS-5-460-11
Jeweler Type Forceps
11 cm Fig. 3c,

SURGICAL INSTRUMENTS

DRESSING & TISSUE FORCEPS



Jewelers
AS-5-461-11
Jeweler Type Forceps
11 cm Fig. 5,



Jewelers
AS-5-462-11
Jeweler Type Forceps
11 cm Fig. 4,



Stille-Barraya
AS-5-463-18
Dissecting Forceps
18 cm,



Bonney
AS-5-464-18
Dissecting Forceps
17.5 cm,



Nelson
AS-5-465-23
Dissecting Forceps
23 cm,

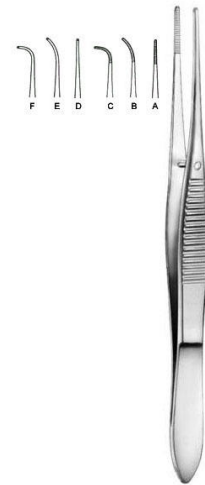

AS-5-466-10
Dressing Forceps
10 cm, 9.5 cm,

SURGICAL INSTRUMENTS

DRESSING & TISSUE FORCEPS



AS-5-467-12
Splinter Forceps smooth jaw
12.5 cm,



AS-5-468-12
Splinter Forceps smooth jaw
12.5 cm,



AS-5-469-12
Splinter Forceps
12.5 cm,



AS-5-470-12
Splinter Forceps
12.5 cm,



AS-5-471-16
Micro Tying Forceps
15.5 cm,



AS-5-472-10
Microscopic Forceps super light, blunt
10 cm,

SURGICAL INSTRUMENTS

DRESSING & TISSUE FORCEPS



AS-5-473-10
Microscopic Forceps
10 cm,



Shaaf
AS-5-474-09
Splinter Forceps
9.5 cm,



Littauer
AS-5-475-08
Cilia Forceps
8.5 cm,



AS-5-476-09
Cilia Forceps
8.5 cm,



Douglas
AS-5-477-09
Cilia Forceps
9 cm,



Douglas
AS-5-478-09
Cilia Forceps
9 cm,

SURGICAL INSTRUMENTS

DRESSING & TISSUE FORCEPS



Beer
AS-5-479-09
Cilia Forceps
9 cm,

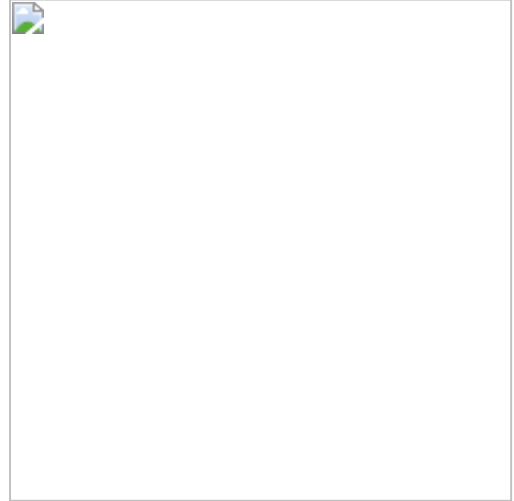

Bryant Dressing Forcep
AS-5-479-10

13 CM, 14 CM,

SURGICAL INSTRUMENTS

SPLINTER FORCEPS



Phaneuf
AS-5-501-21
Hysterectomy Forceps
20.5 cm,



Wertheim-Cullen
AS-5-502-21
Vaginal Clamp
21 cm,

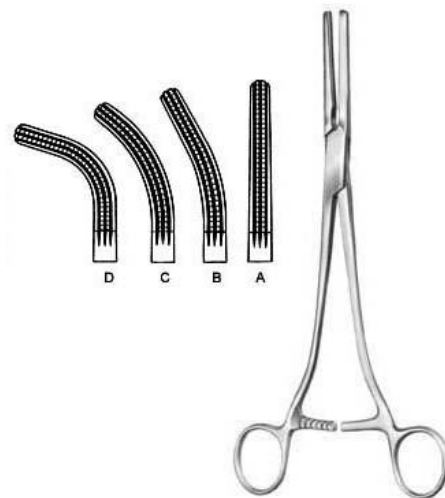

Rogers
AS-5-503-10
Hysterectomy Forceps
21.5 cm Fig. 1, 21 cm Fig. 2, 20.5 cm Fig. 3, 20 cm Fig. 4,



Moynihan
AS-5-504-23
Hysterectomy Forceps
23 cm,



Moynihan
AS-5-505-24
Hysterectomy Forceps
23.5 cm,



Wertheim
AS-5-506-25
Hysterectomy Forceps
26 cm,

SURGICAL INSTRUMENTS

SPLINTER FORCEPS

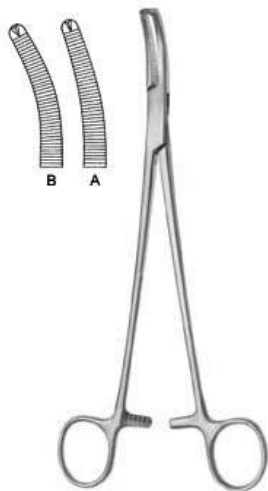

Wertheim
AS-5-507-22
Hysterectomy Forceps
22.5 cm,



Mikulicz, Baby
AS-5-508-14
Peritoneum Forceps
14.5 cm,



Mikulicz
AS-5-509-18
Peritoneum Forceps
20.5 cm,



Mikulicz
AS-5-510-20
Peritoneum Forceps
18.5 cm,



Mikulicz
AS-5-511-20
Peritoneum Forceps
20 cm,



Mikulicz
AS-5-512-21
Peritoneum Forceps
20.5 cm,

SURGICAL INSTRUMENTS

SPLINTER FORCEPS



Faure
AS-5-513-20
Peritoneum Forceps
21 cm,

SURGICAL INSTRUMENTS

HAEMOSTATIC FORCEPS

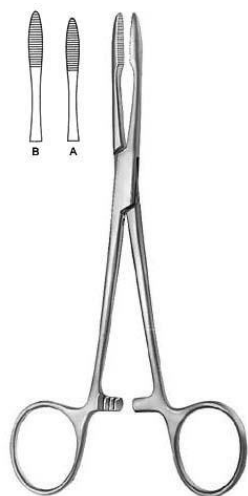

Pean
AS-5-601-14
Haemostatic Forceps
14.5 cm, 16 cm,

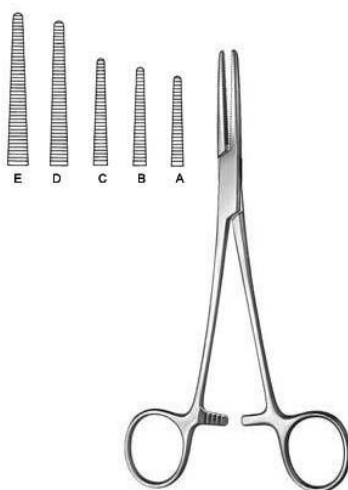

Spencer-Wells
AS-5-602-13
Haemostatic Forceps
13 cm, 14 cm, 15.5 cm, 18.5 cm, 20 cm,

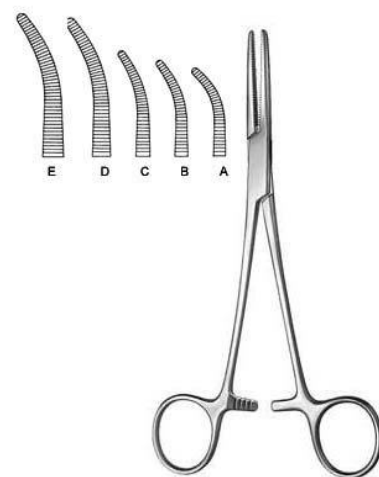

Spencer-Wells
AS-5-603-13
Haemostatic Forceps
13 cm, 14 cm, 15 cm, 18 cm, 20 cm,



Chaput
AS-5-604-13
Haemostatic Forceps
12.5 cm,



Tuffier
AS-5-605-13
Haemostatic Forceps
12.5 cm,

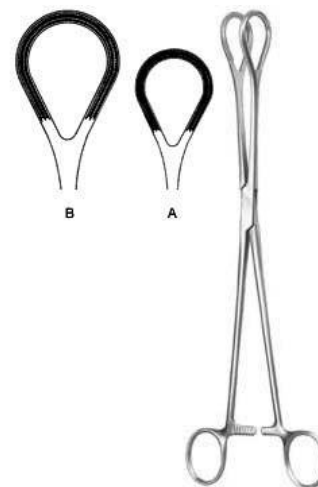

AS-5-606-25
Organ Grasping Forceps

SURGICAL INSTRUMENTS

HAEMOSTATIC FORCEPS



Collin
AS-5-607-14
Organ Grasping Forceps
15.5 cm, 21 cm,



Collin
AS-5-608-17
Tumor Grasping Forceps
17 cm,



Pennington
AS-5-609-15
Haemostatic Forceps
15.5 cm,



Pratt
AS-5-610-15
Haemostatic Forceps
15 cm,



Martel-Rees
AS-5-611-14
Face-lift Forceps
13.5 cm,



AS-5-612-12
Ligature Forceps

SURGICAL INSTRUMENTS

HAEMOSTATIC FORCEPS

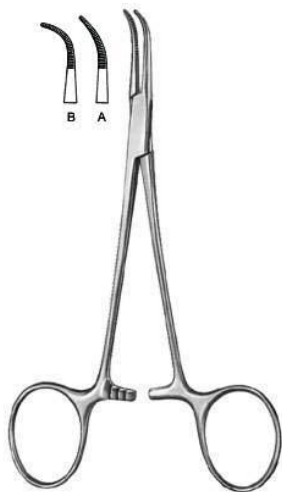

Mixer-Baby
AS-5-613-01

Dissecting and Ligature Forceps
13.5 cm, 13 cm,

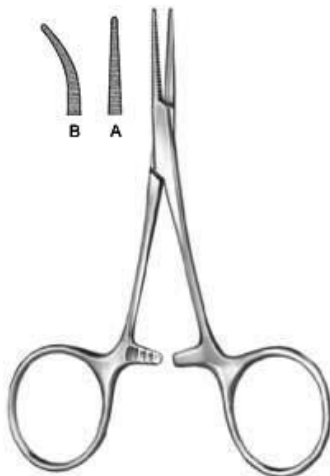

Hartmann
AS-5-614-10

Haemostatic Forceps
10 cm, 9.5 cm,



AS-5-615-12
Ligature Forceps

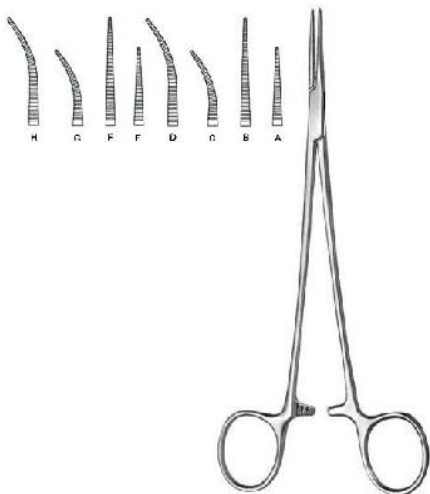

Halsted-Mosquito
AS-5-616-18

Haemostatic Forceps
12.5 cm, 14.5 cm, 14 cm,

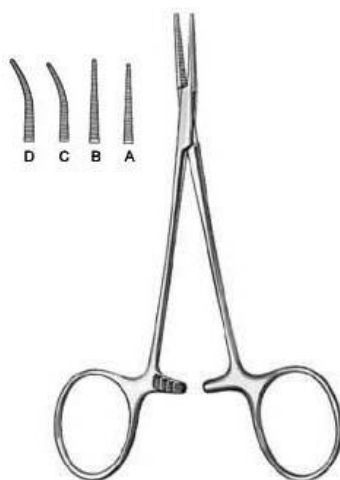

Mikro-Mosquito
AS-5-617-10

Haemostatic Forceps
10 cm, 12 cm, 9.5 cm, 11.5 cm,



Providence-Hospital
AS-5-618-14

Haemostatic Forceps
14 cm,

SURGICAL INSTRUMENTS

HAEMOSTATIC FORCEPS



Leriche
AS-5-619-15
Haemostatic Forceps
15.5 cm, 15 cm,

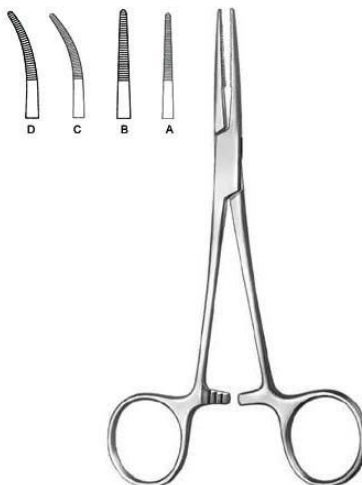

Kelly
AS-5-620-14
Haemostatic Forceps
14.5 cm, 14 cm,

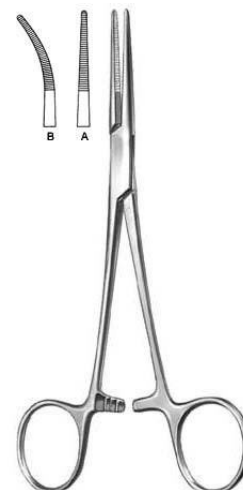

Kelly-Rankin
AS-5-621-16
Haemostatic Forceps
16 cm, 15.5 cm,



Overholt-Baby
AS-5-622-14
Dissecting and Ligature Forceps
14.5 cm, 14 cm,



Crile
AS-5-623-14
Haemostatic Forceps
14.5 cm, 14 cm,

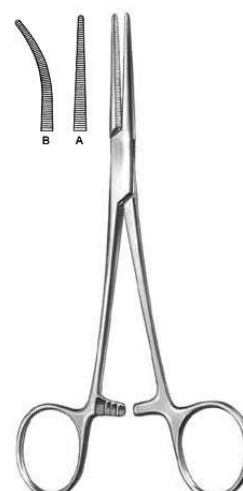

Crile-Rankin
AS-5-624-16
Haemostatic Forceps
16.5 cm, 16 cm,

SURGICAL INSTRUMENTS

HAEMOSTATIC FORCEPS

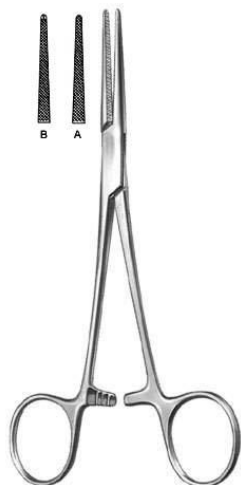

Lovelace
AS-5-625-15
Haemostatic Forceps
16 cm,



Dandy-Mosquito
AS-5-626-12
Haemostatic Forceps
12 cm,

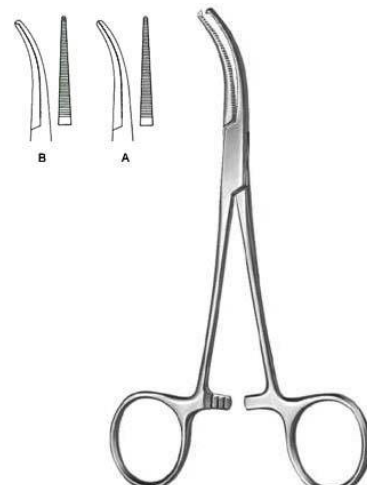

Dandy
AS-5-627-14
Haemostatic Forceps
14.5 cm, 14 cm,



Schidt
AS-5-628-18
Dissecting and Ligature Forceps
18.5 cm, 19 cm,



Adson
AS-5-629-18
Dissecting and Ligature Forceps
19 cm, 18.5 cm,



Martin-Fuchsig
AS-5-630-20
Dissecting and Ligature Forceps
20.5 cm,

SURGICAL INSTRUMENTS

HAEMOSTATIC FORCEPS

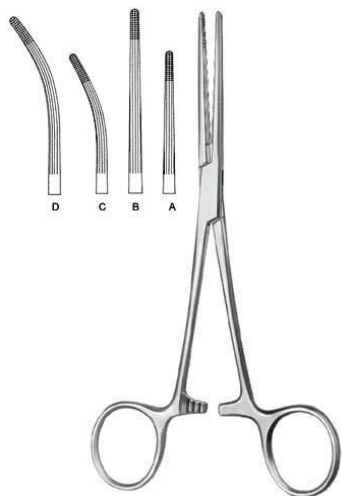

Rochester-Carmalt
AS-5-631-16

Haemostatic Forceps
17 cm, 20.5 cm, 16.5 cm, 20 cm,

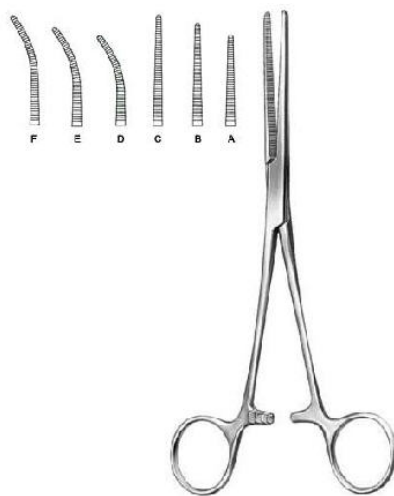

Pean

AS-5-632-13

Haemostatic Forceps
13.5 cm, 14.5 cm, 17 cm, 13 cm, 14 cm, 16.5 cm,

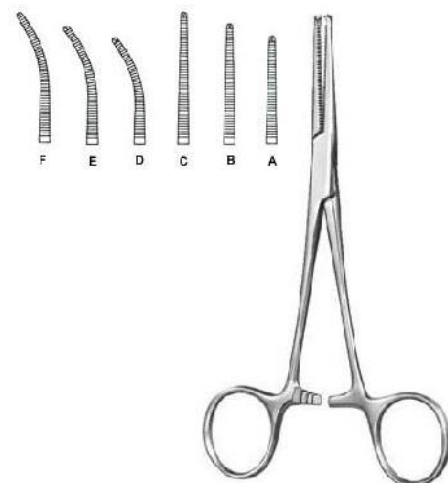

Kocher-Nippon

AS-5-633-14

Haemostatic Forceps
14.5 cm, 16.5 cm, 18.5 cm, 16 cm, 18 cm,

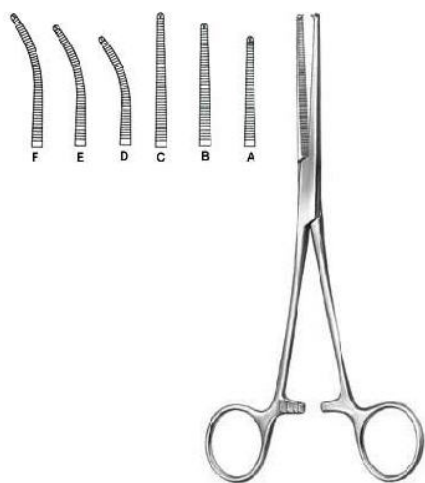

Kocher

AS-5-635-13

Haemostatic Forceps
13 cm, 14 cm, 16 cm,

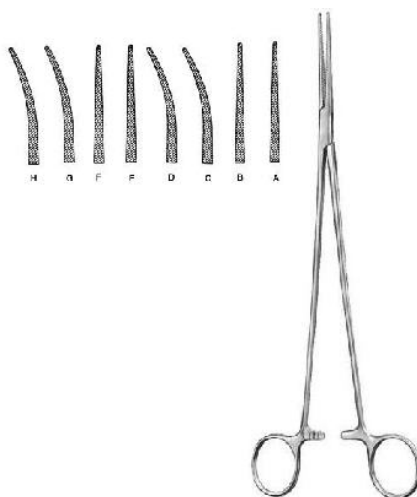

Bengolea

AS-5-636-20

Haemostatic Forceps
21.5 cm, 26 cm, 21 cm, 21.5 cm,

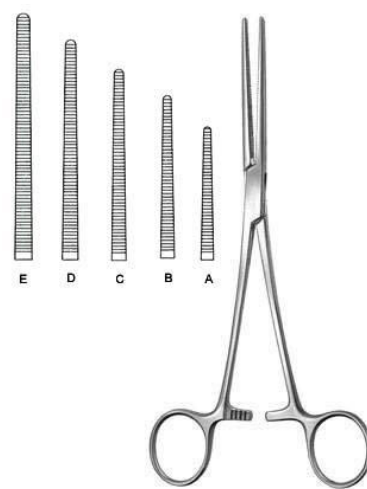

Pean (Rochester)

AS-5-637-14

Haemostatic Forceps
14.5 cm, 16.5 cm, 18.5 cm, 20.5 cm, 22.5 cm, 24.5 cm, 26 cm, 30.5 cm, 14 cm, 16 cm,

SURGICAL INSTRUMENTS

HAEMOSTATIC FORCEPS

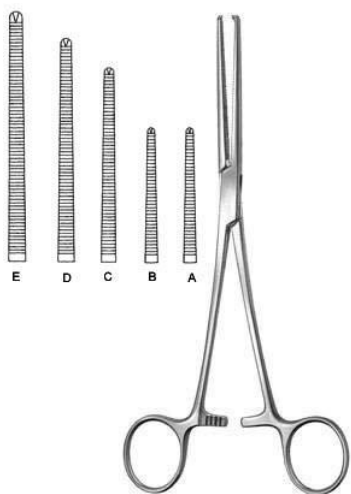

Kocher (Ochsner)
AS-5-638-14

Haemostatic Forceps
14.5 cm, 16.5 cm, 18.5 cm, 20.5 cm, 22.5 cm, 24.5 cm, 26 cm, 30.5 cm,

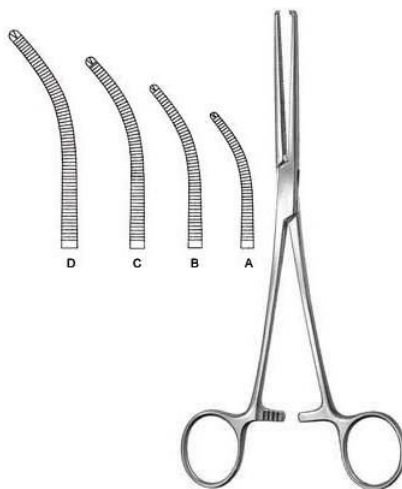

Kocher (Ochsner)
AS-5-639-14

Haemostatic Forceps
14 cm, 16 cm, 18 cm, 20 cm, 22 cm, 24 cm, 25.5 cm, 30 cm,

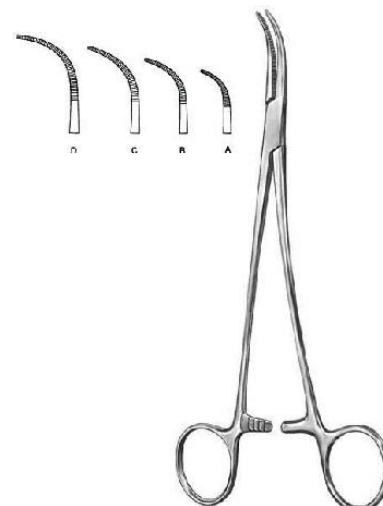

Overholt-Martin
AS-5-640-01

Dissecting and Ligature Forceps
18.5 cm Fig. 1, 20.5 cm Fig. 2, 21 cm Fig. 3, 21.5 cm Fig. 4, 24.5 cm Fig. 5,



Mixer-Baby
AS-5-641-18

Dissecting and Ligature Forceps
18.5 cm,



Adson-Baby
AS-5-642-14

Dissecting and Ligature Forceps
14.5 cm, 18 cm,



Heiss
AS-5-643-20

Dissecting and Ligature Forceps
21 cm, 20.5 cm, 20 cm,

SURGICAL INSTRUMENTS

HAEMOSTATIC FORCEPS



Overholt-Mixter
AS-5-644-21

Dissecting and Ligature Forceps
21.5 cm,

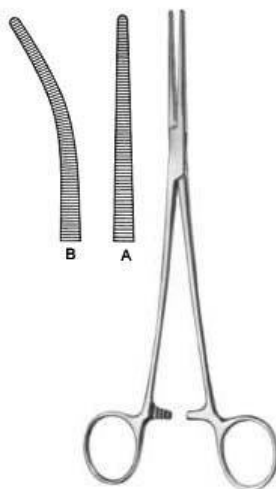

Roberts

AS-5-645-22

Dissecting and Ligature Forceps
22.5 cm, 21.5 cm,

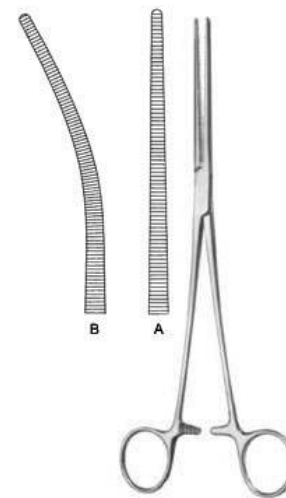

Sarot

AS-5-646-24

Dissecting and Ligature Forceps
25 cm, 24.5 cm,

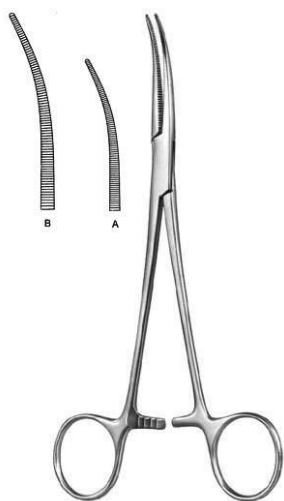

Crafoord

AS-5-647-18

Dissecting and Ligature Forceps
18 cm, 24.5 cm,

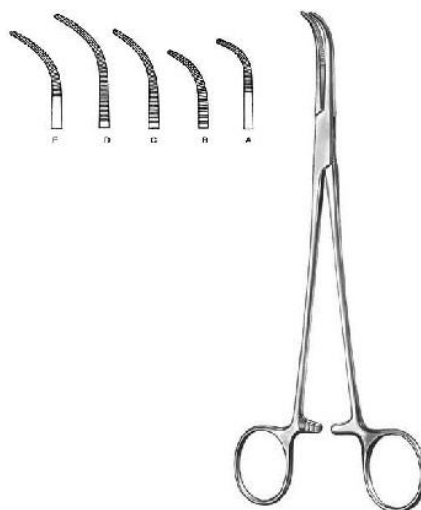

Overholt-Geissendorfer

AS-5-648-01

Dissecting and Ligature Forceps
20.5 cm Fig. 1, 20 cm Fig. 2, 21.5 cm Fig. 3, 22 cm Fig. 4, 21.5 cm Fig. 5, 22 cm Fig. 6, 27 cm Fig. 1, 26.5 cm Fig. 2, 27.5 cm Fig. 3, 28 cm Fig. 4,

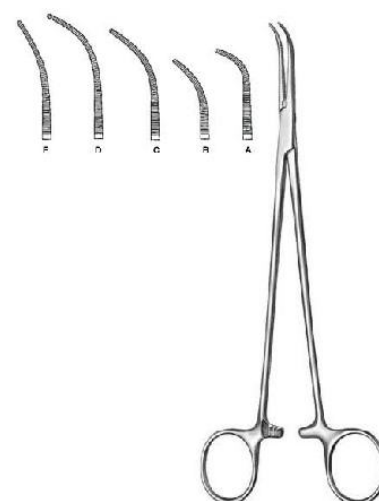

Overholt-Fino

AS-5-649-00

Dissecting and Ligature Forceps
21.5 cm, 21 cm, 22 cm, 23 cm, 22.5 cm,

SURGICAL INSTRUMENTS

HAEMOSTATIC FORCEPS

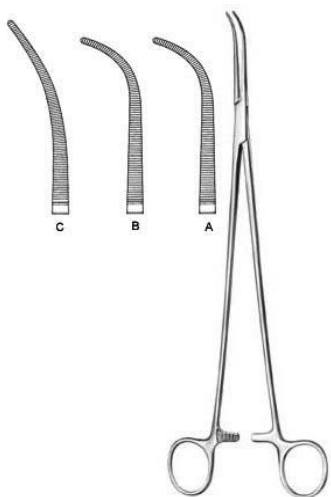

Overholt

AS-5-650-00

Dissecting and Ligature Forceps
29.5 cm, 30 cm,



Overholt-Mini

AS-5-651-01

Dissecting and Ligature Forceps
15 cm, 20 cm,

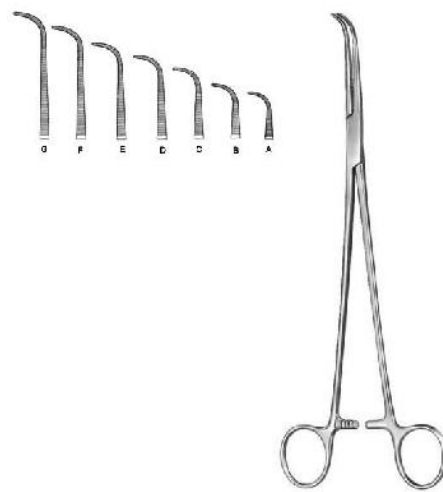

Gemini

AS-5-652-13

Dissecting and Ligature Forceps
13 cm, 16 cm, 18 cm, 21 cm, 23 cm, 25 cm, 28 cm,

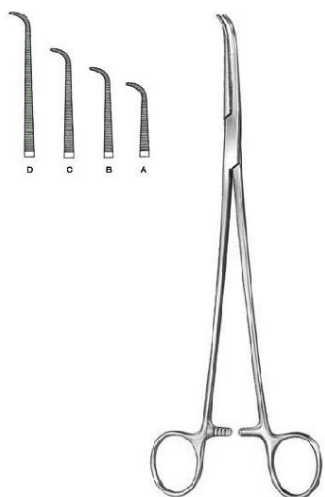

Mini-Gemini

AS-5-653-18

Dissecting and Ligature Forceps
18 cm, 22.5 cm, 25 cm, 28.5 cm,

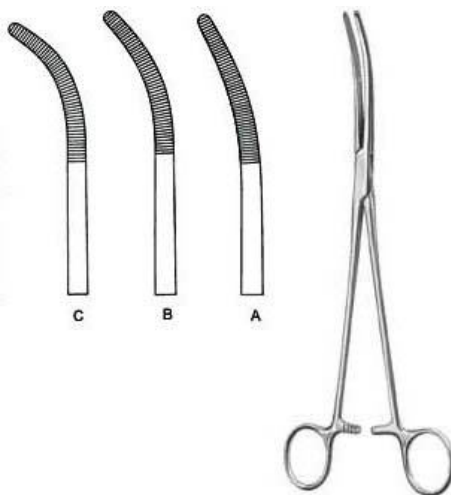

Rumel

AS-5-654-01

Dissecting and Ligature Forceps
24 cm Fig. 1, 23.5 cm Fig. 2, 23 cm Fig. 3, 24 cm Fig. 4, 23.5 cm Fig. 5,

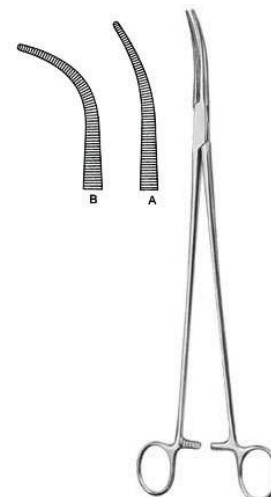

Zenker

AS-5-655-01

Dissecting and Ligature Forceps
29.5 cm, 28.5 cm,

SURGICAL INSTRUMENTS

HAEMOSTATIC FORCEPS



Mixer-Baby
AS-5-656-14

Dissecting and Ligature Forceps
13.5 cm,

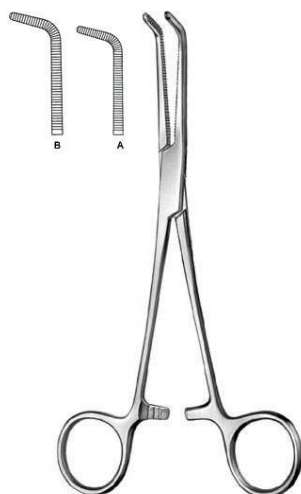

Mixer

AS-5-657-15

Dissecting and Ligature Forceps
16 cm, 18 cm,



Mixer-O Shaughnessy

AS-5-658-19

Dissecting and Ligature Forceps
18 cm,



Mixer

AS-5-659-22

Dissecting and Ligature Forceps
22.5 cm,



Mixer

AS-5-660-23

Dissecting and Ligature Forceps
23 cm,



Wickstrom

AS-5-661-21

Dissecting and Ligature Forceps
21 cm, 24.5 cm,

SURGICAL INSTRUMENTS

HAEMOSTATIC FORCEPS

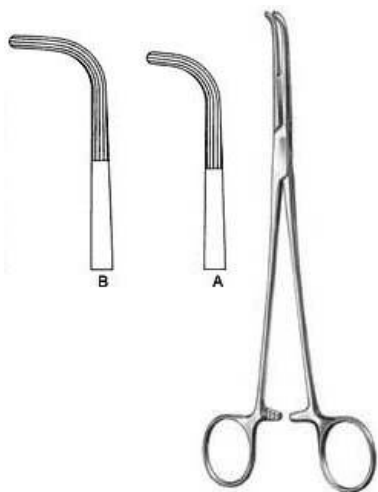

Mixer

AS-5-662-22

Dissecting and Ligature Forceps
22.5 cm, 26 cm, 28 cm,



Mc Quigg-Mixer

AS-5-663-22

Dissecting and Ligature Forceps
23.5 cm,



Lower

AS-5-664-18

Dissecting and Ligature Forceps
18.5 cm,

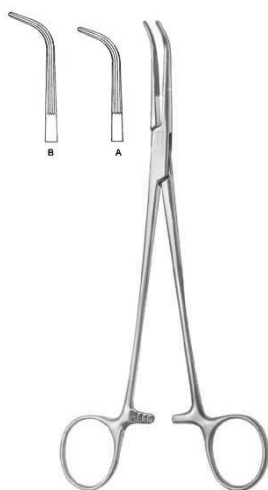

Lahey

AS-5-665-19

Bile Duct Clamp
19.5 cm, 22.5 cm,



Finochietto

AS-5-666-24

Dissecting and Ligature Forceps
24 cm,



Uro-Tangential

AS-5-667-01

Tangential Forceps
25 cm, 27 cm,

SURGICAL INSTRUMENTS

HAEMOSTATIC FORCEPS

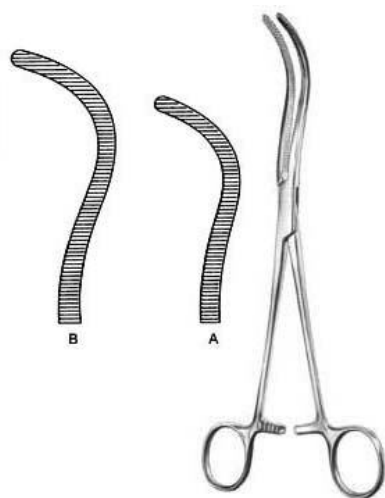

Guyon

AS-5-668-20

Kidney Pedicle Clamp
23 cm, 24 cm,



Guyon

AS-5-669-23

Kidney Pedicle Clamp
19.5 cm, 21.5 cm, 24 cm,



Desjardins

AS-5-670-21

Bile Duct Clamp
21 cm,

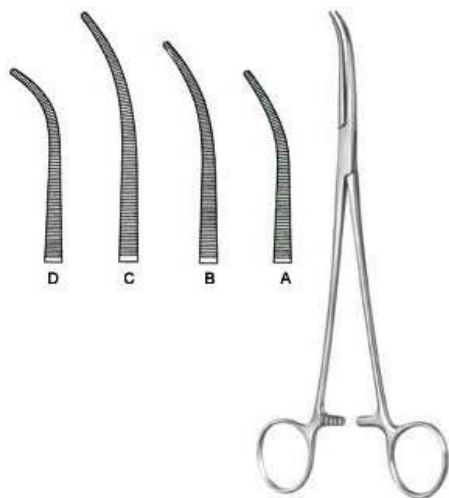

Kelly

AS-5-671-19

Dissecting and Ligature Forceps

19.5 cm Fig. 1, 22.5 cm Fig. 1, 24.5 cm Fig.

1, 19 cm Fig. 2, 22 cm Fig. 2, 24 cm Fig.

2, 18.5 cm Fig. 3, 21.5 cm Fig. 3, 23.5 cm Fig.

3,



Lawrence

AS-5-672-28

Dissecting and Ligature Forceps
28 cm,



Meeker

AS-5-673-28

Dissecting and Ligature Forceps
28 cm,

SURGICAL INSTRUMENTS

HAEMOSTATIC FORCEPS

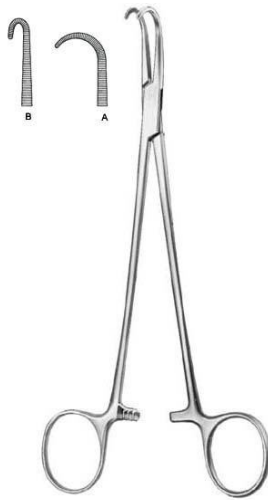

Negus
AS-5-674-19
Haemostatic Forceps
19.5 cm Fig. 1, 20 cm Fig. 2,

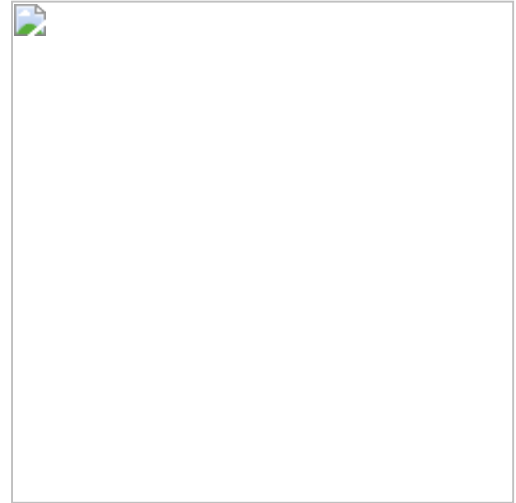

McGIVNEY LIGATOR
AS-5-675-20
Grasping Forceps Shaft Size 23 cm / 9 Inch
& Ligator Plier 20 cm / 8 Inch &
Loading Cone Stainless Stess Smooth
Finished nbsp;nbsp;
Standard Size set,

SURGICAL INSTRUMENTS

TOWEL & TUBING CLAMPS



Schaedel
AS-5-701-09
Towel Clamp sharp
9 cm,



Jones
AS-5-702-05
Towel Clamp sharp
5.5 cm, 8.5 cm,



Jones-Martin
AS-5-703-09
Towel Clamp sharp
8.5 cm,



Backhaus
AS-5-704-11
Towel Clamp
11.5 cm, 13 cm,



Backhaus
AS-5-705-11
Towel Clamp
11.5 cm,



Backhaus
AS-5-706-08
Towel Clamp
9 cm, 11.5 cm, 13 cm, 16 cm,

SURGICAL INSTRUMENTS

TOWEL & TUBING CLAMPS



Peers-Bertram modif.

AS-5-707-15

Towel Clamp wide jaw for tube fixation
15.5 cm,



Roder

AS-5-708-13

Towel Clamp
13.5 cm,

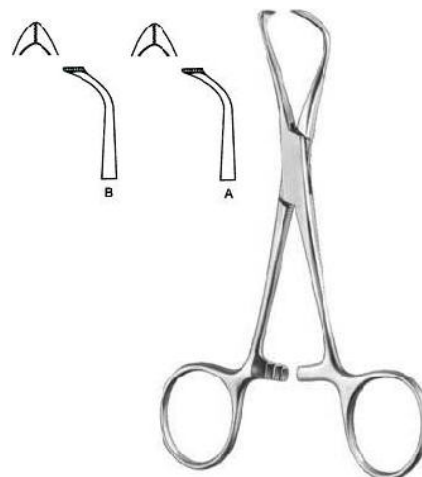

Lorna

AS-5-709-10

Towel Clamp fine serrated, wide jaw
9.5 cm, 13 cm,



Bernhard

AS-5-710-16

Towel Clamp
16.5 cm,

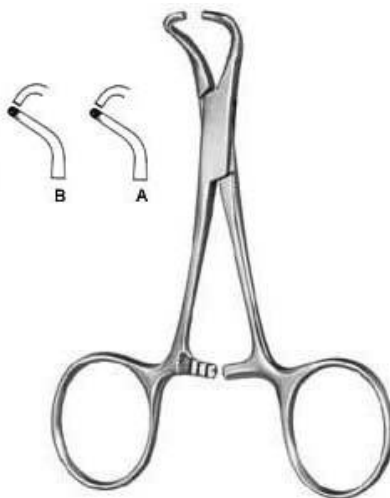

Tohoku

AS-5-711-10

Towel Clamp
10.5 cm blunt, 13.5 cm blunt, 14.5 cm,

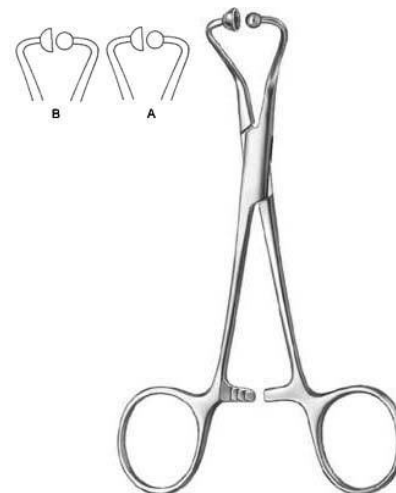

AS-5-712-11

Towel Clamp for paper clothes
11.5 cm, 14 cm,

SURGICAL INSTRUMENTS

TOWEL & TUBING CLAMPS



Lane
AS-5-713-20
Towel Clamp
19.5 cm,



AS-5-714-06
Tube Holder for fixation of six tubes



AS-5-715-14
Tubing Clamp extra long ratchet
14 cm,



AS-5-716-16
Tubing Clamp
16.5 cm,

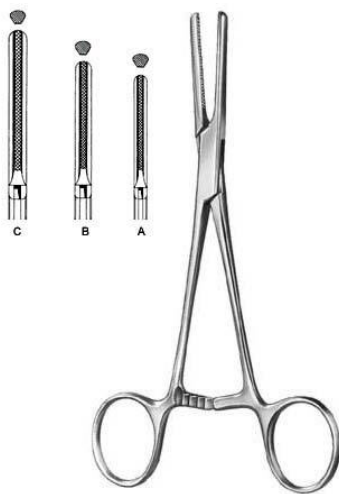

AS-5-717-15
Tubing Clamp
15.5 cm, 19 cm, 20.5 cm,

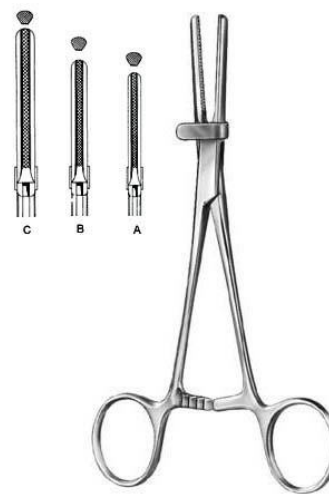

AS-5-718-15
Tubing Clamp with safety guard
15.5 cm, 19 cm, 20.5 cm,

SURGICAL INSTRUMENTS

DRESSING & SPONGE FORCEPS

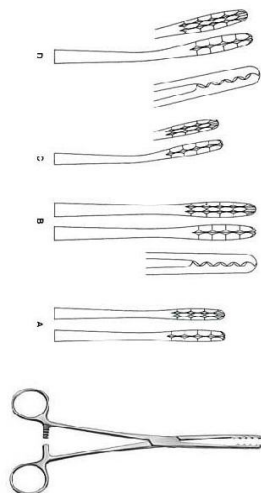

Ulrich

AS-5-801-22

Dressing Forceps
22.5 cm, 26.5 cm,

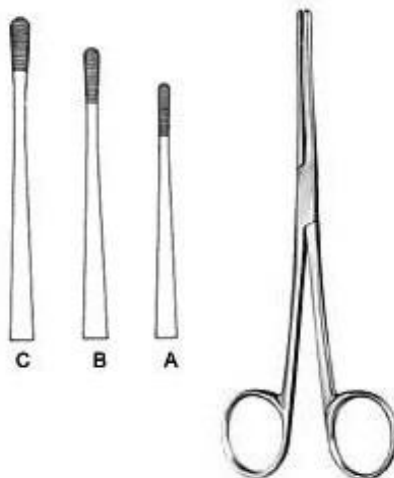

Lister

AS-5-802-13

Sinus Forceps
13 cm, 16 cm, 18 cm,

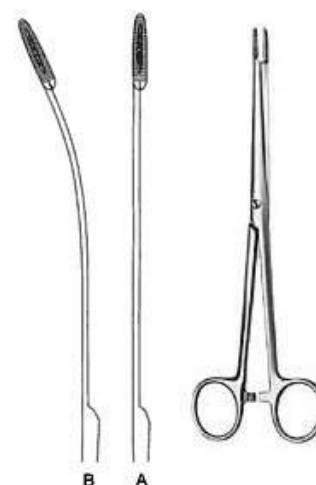

Martin

AS-5-803-17

Dressing Forceps
17.5 cm, 17 cm,

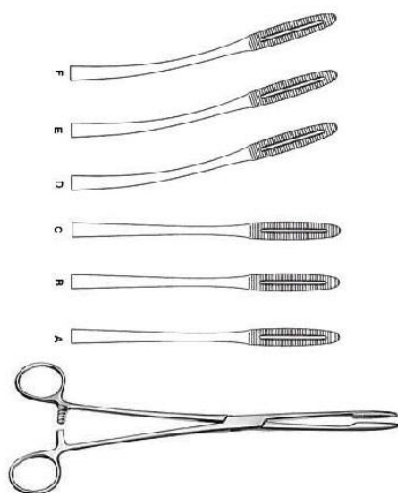

Gross-Maier

AS-5-804-20

Dressing Forceps
20.5 cm, 22 cm, 26.5 cm, 20 cm, 21.5 cm, 26 cm,



AS-5-805-40

Tunneling Forceps
39.5 cm,



Collin

AS-5-806-25

Dressing Forceps
25.5 cm,

SURGICAL INSTRUMENTS

DRESSING & SPONGE FORCEPS



Cheron
AS-5-807-25
Dressing Forceps
23.5 cm,



Bozemann
AS-5-808-26
Sponge Forceps
26 cm,

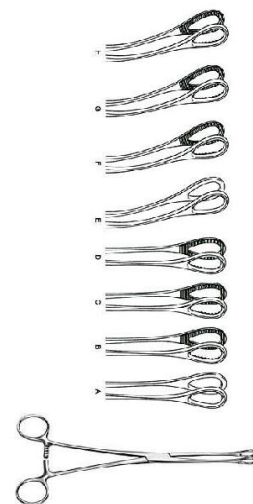

Foerster
AS-5-809-25
Sponge Forceps
25 cm, 18 cm, 20.5 cm, 24.5 cm, 17.5 cm, 20 cm, 24.5 cm,

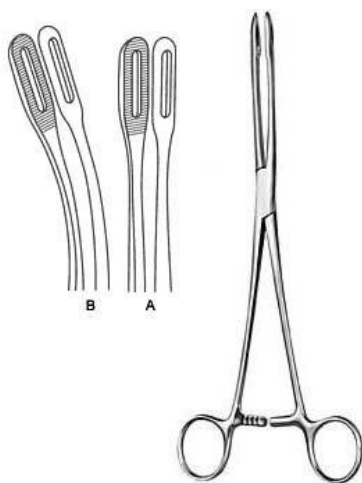

Foerster
AS-5-810-25
Sponge Forceps
25 cm, 24.5 cm,

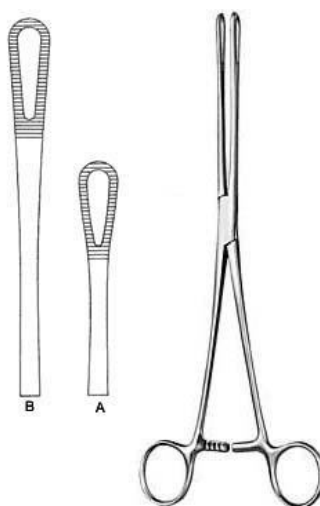

Rampley
AS-5-811-18
Sponge Forceps
18.5 cm, 24.5 cm,

SURGICAL INSTRUMENTS

PROBES



AS-5-1001-11

Probe

11.5 cm, 13 cm, 14.5 cm, 16 cm, 18 cm, 20 cm, 25 cm, 30 cm,



AS-5-1002-11

Probe

11.5 cm, 13 cm, 14.5 cm, 16 cm, 18 cm, 20 cm, 25 cm, 30 cm,

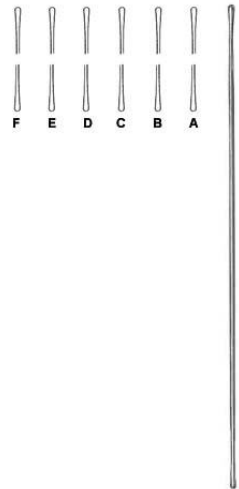

AS-5-1003-13

Probe

13 cm, 14.5 cm, 16 cm, 18 cm, 20 cm, 25 cm,



AS-5-1004-13

Probe with eye

13 cm, 14.5 cm, 16 cm,

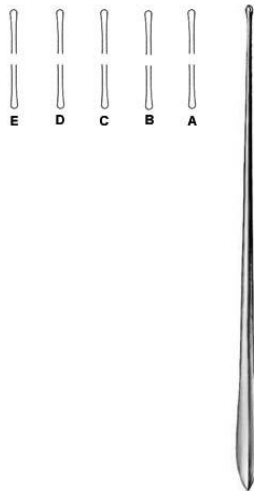

AS-5-1006-13

Myrtle Leaf Probe

13 cm, 14.5 cm, 16 cm, 18 cm, 20 cm,



AS-5-1007-13

Grooved Director

13 cm, 14 cm, 16 cm,

SURGICAL INSTRUMENTS

PROBES



AS-5-1008-13
Grooved Director
13 cm, 14.5 cm, 16 cm,



Doyen
AS-5-1009-14
Grooved Director
14.5 cm,



Nelaton
AS-5-1010-16
Grooved Director
16 cm,

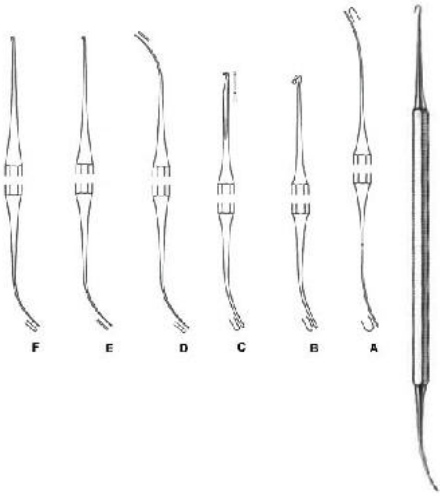

Varady
AS-5-1011-01
Phlebotomizer
18 cm, 17.5 cm,

SURGICAL INSTRUMENTS

PLASTER

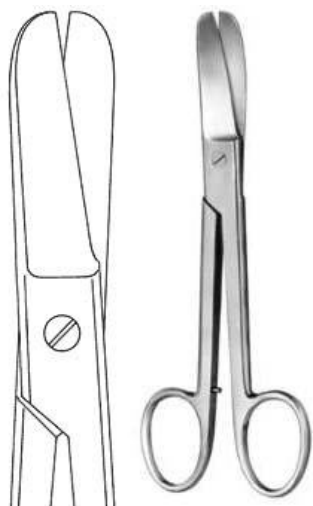

Lorenz
AS-6-101-23
Bandage Scissors heavy pattern
23 cm,



Lister
AS-6-102-14
Bandage Scissors
14.5 cm, 18.5 cm, 20 cm,



Bergmann
AS-6-103-23
Plaster Shears
23.5 cm,



Esmarch
AS-6-104-20
Plaster Shears heavy pattern, short blades
20 cm,



AS-6-105-15
Bandage Scissors black plastic ring with
autodavable
16 cm, 19 cm,



AS-6-106-18
Bandage Scissors black plastic rings
19 cm, 16 cm,

SURGICAL INSTRUMENTS

PLASTER

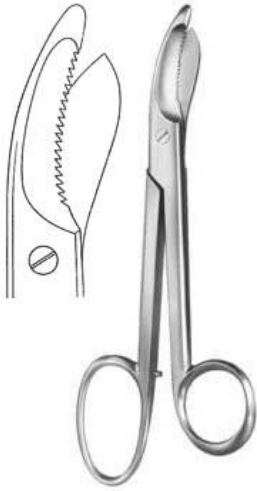

Bruns
AS-6-107-24
Plaster Scissors
24 cm,

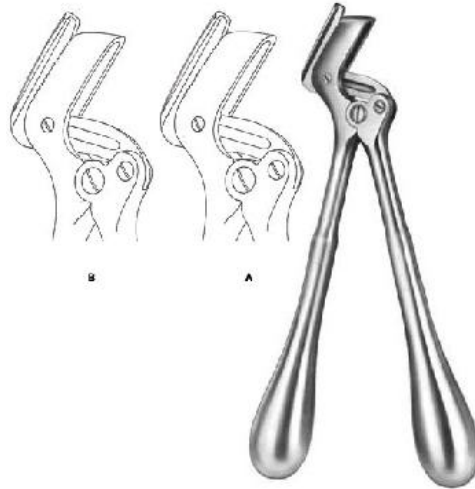

Stille-Martin
AS-6-108-23
Plaster Shears
23 cm, 27 cm, 38 cm,

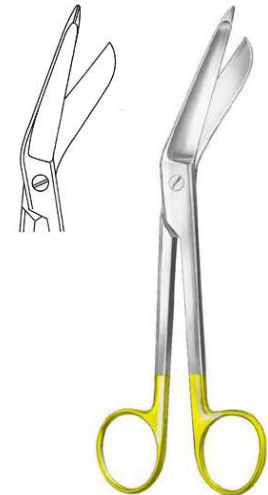

Lister
AS-6-109-18
Bandage Scissors
18 cm,

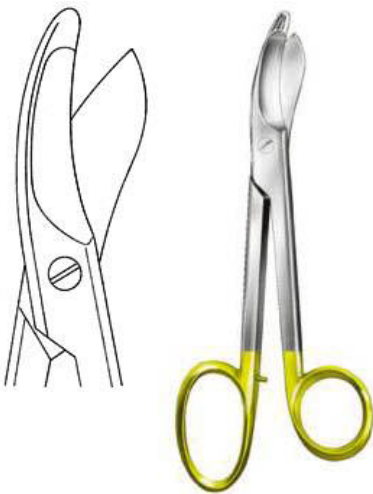

Bruns
AS-6-110-24
Plaster Scissors
24 cm,



Hopkins
AS-6-111-20
Plaster Knife with wooden handle
20 cm,



Reiner
AS-6-112-18
Plaster Knife
18 cm,

SURGICAL INSTRUMENTS

PLASTER



Reiner
AS-6-113-18
Plaster Knife
18 cm,



Martin
AS-6-114-21
Plaster Knife with wooden handle
21 cm,



Engel
AS-6-115-14
Plaster Saw
15.5 cm,

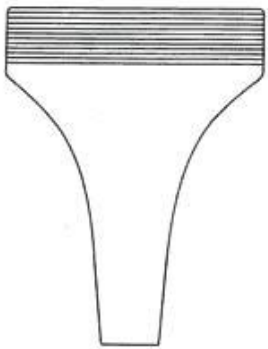

Hennig
AS-6-116-28
Plaster Spreader
28 cm,

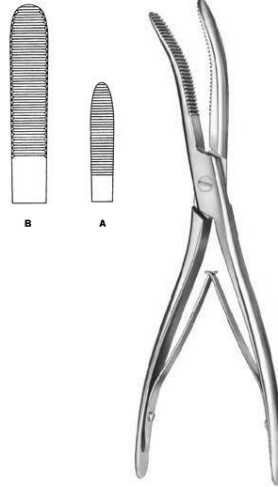

Wolff
AS-6-117-18
Plaster Breaker
18 cm, 26.5 cm,

SURGICAL INSTRUMENTS

NEUROSURGERY



Gigli
AS-8-101-01
Wire Saw Handle



De Martel
AS-8-102-33
Wire Saw Guide
33 cm,



Crutchfield
AS-8-103-01
Skull Traction Tong small pattern



AS-8-104-01
Skull Traction Tong large pattern
22.5 cm,



Dahlgren
AS-8-105-20
Cranial Rongeur
20 cm,



Olivecrona-Toennis
AS-8-106-14
Clip Applying Forceps

SURGICAL INSTRUMENTS

NEUROSURGERY



McKenzie
AS-8-107-19
Clip Applying Forceps
18.5 cm,



Olivecrona
AS-8-108-18
Dura Dissector
18 cm,



Olivecrona
AS-8-109-19
Dura Dissector
20 cm,



Milligan
AS-8-110-21
Dura Dissector
21.5 cm,



Davis
AS-8-111-21
Dura Dissector sharp
21.5 cm,



AS-8-112-22
Dura Dissector
22 cm,

SURGICAL INSTRUMENTS

NEUROSURGERY



Davis
AS-8-113-24
Dura Dissector
24.5 cm,



Love
AS-8-114-19
Nerve Root Retractor
21.5 cm, 18 cm, 11 cm,



Olivecrona
AS-8-115-18
Brain Spatula
18 cm,



Scoville
AS-8-116-23
Nerve Root Retractor 8mm
23.5 cm,



Holsher
AS-8-117-24
Nerve Root Retractor 8mm
23.5 cm,



Scoville
AS-8-118-19
Nerve Root Retractor 7mm
16.5 cm,

SURGICAL INSTRUMENTS

NEUROSURGERY



Groningen
AS-8-119-26
Nerve Hook
26.5 cm,



Groningen
AS-8-120-26
Nerve Hook
26.5 cm,



Cushing
AS-8-121-19
Nerve Hook blunt
19 cm, 28 cm,

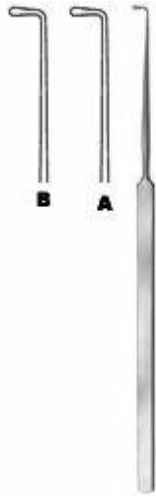

Cushing
AS-8-122-19
Nerve Hook
19.5 cm, 28 cm,



Smithwick
AS-8-123-17
Nerve Hook
17 cm, 21 cm,



Halle
AS-8-125-20
Dura Knife
20 cm,

SURGICAL INSTRUMENTS

NEUROSURGERY



Adson
AS-8-126-20
Dura Hook
20 cm,



Graham
AS-8-127-16
Dura Hook blunt
16.5 cm,



Sachs
AS-8-128-18
Dura Hook sharp
18 cm,



Toennis
AS-8-129-15
Dura Hook sharp
14.5 cm,



Frazier
AS-8-130-13
Dura Hook sharp
13 cm, 18 cm,



Krayenbuhl
AS-8-131-01
Nerve and Vessel Hooklet
18.5 cm Fig. 1, 18.5 cm Fig. 2,

SURGICAL INSTRUMENTS

NEUROSURGERY



Cloward
AS-8-132-16
Lamina Spreader
16 cm,

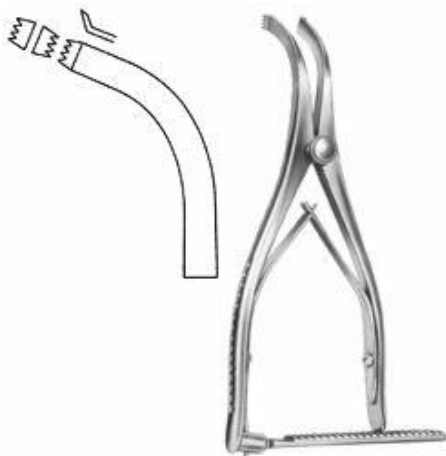

Inge
AS-8-133-17
Lamina Spreader
16 cm,

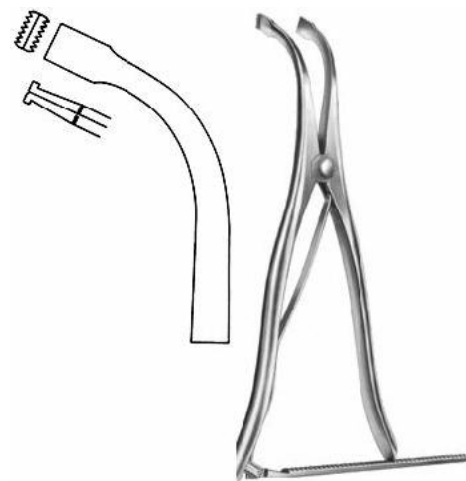

Inge
AS-8-134-27
Lamina Spreader
25.5 cm,

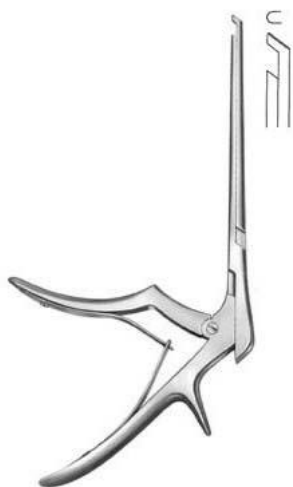

Ferris-Smith Kerrison
AS-8-135-03
Laminectomy Punch 3mm downwards
cutting 40 degree shaft length 180 mm

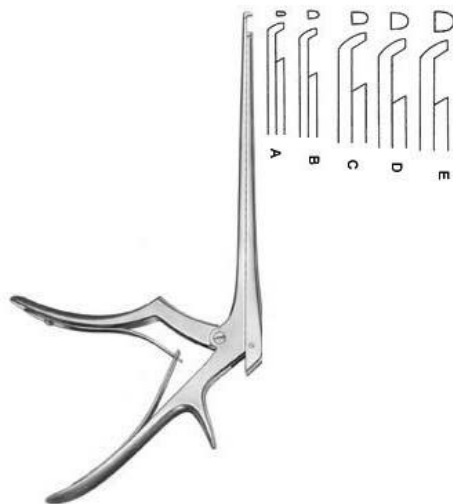

Ferris-Smith Kerrison
AS-8-138-01
Laminectomy Punch upwards cutting shaft
length 180 mm
1 mm, 2 mm, 3 mm, 4 mm, 5 mm, 6 mm,

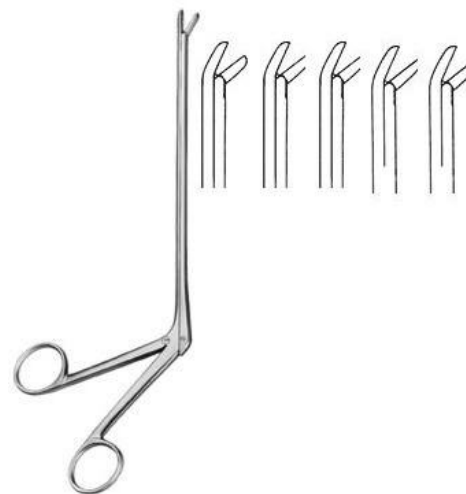

Cushing
AS-8-139-01
Laminectomy Rongeur jaw 2 x 10 to 4 x 10
mm straight shaft length 180 mm

SURGICAL INSTRUMENTS

NEUROSURGERY

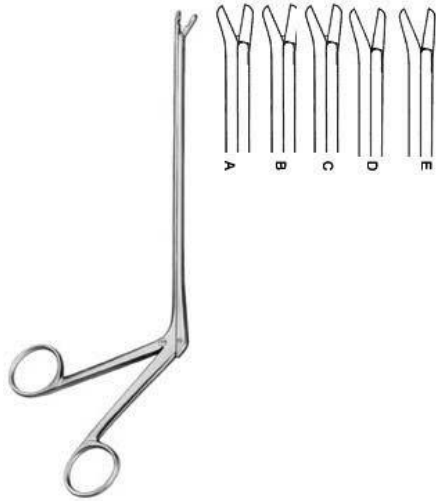

Cushing

AS-8-140-01

Laminectomy Rongeur jaw 2 x 10 to 4 x 10 mm upwards 45 degree shaft length 120 mm



Ferris-Smith Kerrison

AS-8-137-01

Laminectomy Punch
1 mm, 2 mm, 3 mm, 4 mm, 5 mm, 6 mm,

SURGICAL INSTRUMENTS

CARDIOVASCULAR



AS-9-101-23
Bone Shear
23 cm,



AS-9-102-22
Rib Shear
23 cm,



Gluck
AS-9-103-22
Rib Shears
21 cm,



Giertz-Stille
AS-9-104-27
Rib Shear
24.5 cm,



Lebsche
AS-9-105-24
Sternum Chisel
24.5 cm,



AS-9-106-01
Rib Retractor lateral blades 12 x 16 mm
spreading 95 mm
Size 1,

SURGICAL INSTRUMENTS

CARDIOVASCULAR



Finochietto, Infant
AS-9-107-01

Rib Retractor lateral blades 15 x 15 mm
spreading 75 mm
Size 1,



Finochietto, Baby
AS-9-108-01

Rib Retractor lateral blades 31 x 31 mm
spreading 100 mm
Size 1,



Finochietto
AS-9-109-01

Rib Retractor lateral blades 40 x 45 mm
spreading 135 mm
Size 1,



Burford
AS-9-110-01

Rib Retractor with two pairs of blades 47 x 62 mm + 65 x 62 mm, spreading 200 mm
Size 1,



Castaneda
AS-9-111-01

Rib Retractor lateral blades 10,5 x 32 mm
spreading 65 mm
Size 1,



Finochietto (modif.)
AS-9-112-01

Rib Retractor lateral blades 14 x 15 mm
spreading 120 mm
Size 1,

SURGICAL INSTRUMENTS

CARDIOVASCULAR



Haight
AS-9-113-90

Rib Retractor lateral blades 30 x 30 mm
spreading 120 mm
Size 1,



Morse-Favaloro
AS-9-114-01

Sternal Retractor 4 movable blades 17 x 22
mm spreading 160 mm Sternal Retractor
Size 1,



Morse
AS-9-115-00

Sternal Retractor 4 movable blades 22 x 27
mm spreading 200 mm
Size 1,



Tuffier
AS-9-116-02

Rib Retractor lateral blades 22 x 27 mm
spreading 200 mm
Size 1,

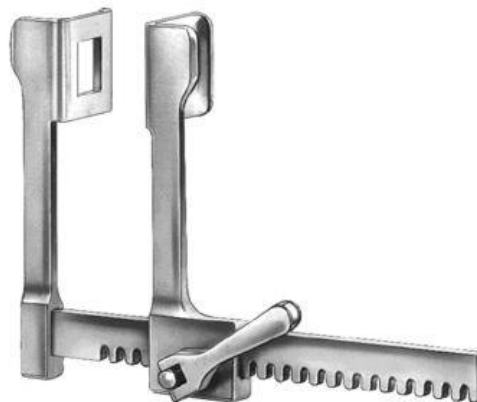

Finochietto, Baby
AS-9-117-75

Rib Retractor lateral blades 14 x 15 mm
spreading 75 mm
Size 1,



Finochietto
AS-9-118-01

Rib Retractor lateral blades 30 x 45 mm
spreading 150 mm
Size 1,

SURGICAL INSTRUMENTS

CARDIOVASCULAR



DeBakey

AS-9-119-00

Rib Retractor spreading 150 mm
Size 1,



DeBakey

AS-9-120-00

Rib Retractor spreading 200 mm
Size 1,



AS-9-121-00

Thoracic Retractor
Size 1,



Sellors

AS-9-122-19

Rib Contractor
20 cm,



Bailey-Baby

AS-9-123-14

Rib Contractor
15.5 cm,



Bailey

AS-9-124-16

Rib Contractor
20 cm,

SURGICAL INSTRUMENTS

CARDIOVASCULAR



Bailey-Gibbon
AS-9-125-16
Rib Contractor
20 cm,



Allison
AS-9-126-30
Lung Spatula
29.5 cm, 32.5 cm,



Price-Thomas
AS-9-127-22
Bronchus Clamp
22 cm,



Price-Thomas
AS-9-128-22
Bronchus Clamp
22 cm,

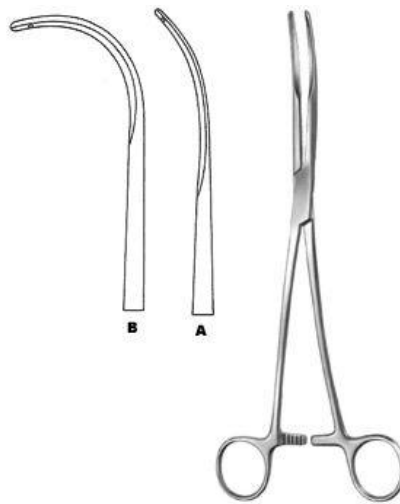

Semb
AS-9-129-24
Bronchus Clamp
24.5 cm,

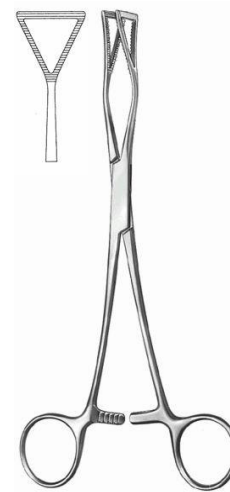

Lovelace
AS-9-130-20
Lung Grasping Forceps
20.5 cm,

SURGICAL INSTRUMENTS

CARDIOVASCULAR

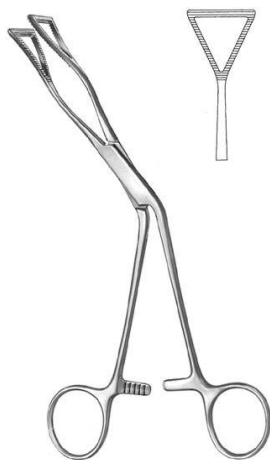

Lovelace
AS-9-131-20
Lung Grasping Forceps
19 cm,



DeBakey-Satinsky
AS-9-132-07
Bulldog Clamp
7 cm,9 cm,



Glover
AS-9-133-06
Bulldog Clamp
6 cm,



Santulli
AS-9-134-07
Bulldog Clamp
7 cm,



Gregory, soft
AS-9-135-09
Bulldog Clamp
9 cm,11 cm,



Gregory
AS-9-136-01
Bulldog Clamp
10.5 cm,

SURGICAL INSTRUMENTS

CARDIOVASCULAR

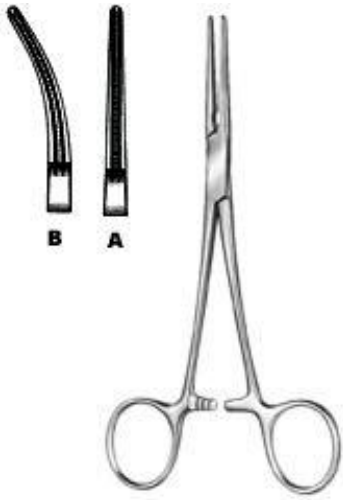

DeBakey-Rankin
AS-9-137-16
Haemostatic Forceps
16 cm,



DeBakey-Mosquito
AS-9-138-15
Haemostatic Forceps
15 cm,



Ochsner
AS-9-139-23
Aortic Clamp
23.5 cm,



Diethrich
AS-9-140-21
Aortic Clamp
22 cm,

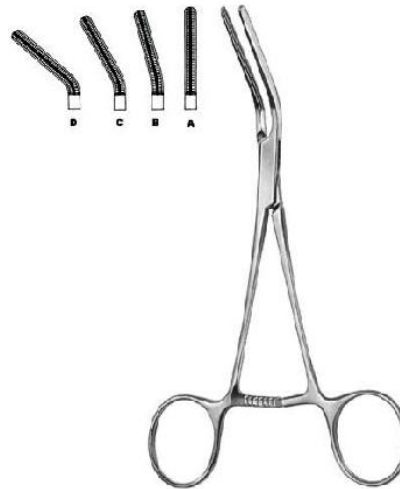

Dardik
AS-9-141-00
Multi purpose Vascular Clamp
15 cm,



Dale
AS-9-142-18
Peripheral Vascular Clamp
18 cm,

SURGICAL INSTRUMENTS

CARDIOVASCULAR

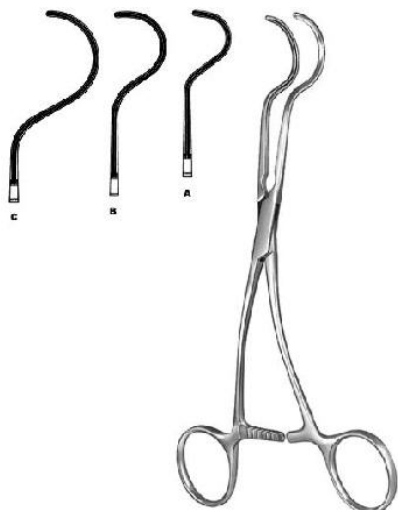

Dale
AS-9-143-17
Peripheral Vascular Clamp
17.5 cm,

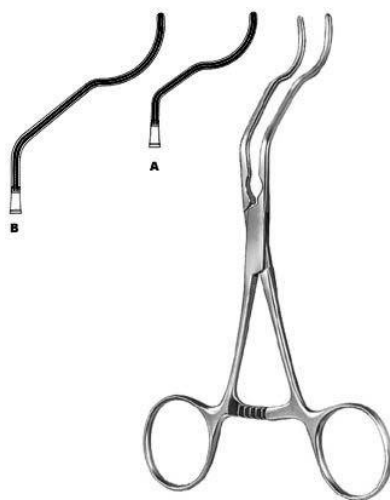

Gregory
AS-9-144-14
Profunda Clamp
13 cm, 16 cm, 18 cm,

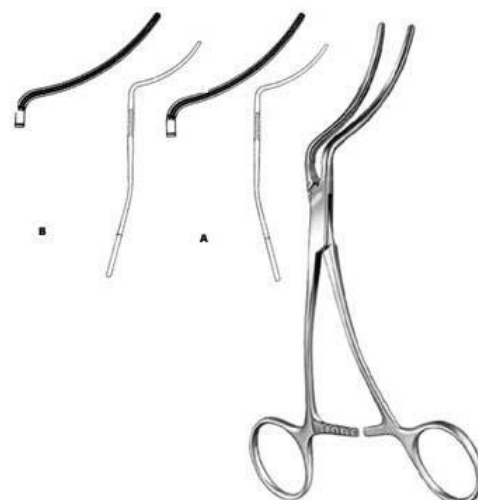

Martin
AS-9-145-16
Peripheral Vascular Clamp
16.5 cm,



Husfeldt
AS-9-146-18
Peripheral Vascular Clamp
17.5 cm,



Husfeldt
AS-9-147-18
Profunda Clamp
18 cm,

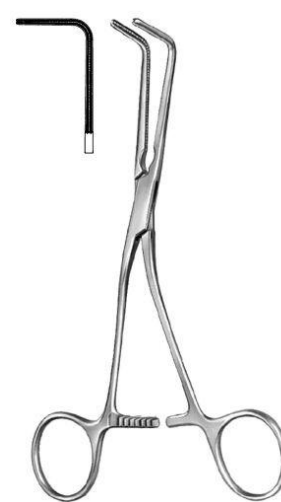

Husfeldt
AS-9-148-17
Peripheral Vascular Clamp
17 cm,

SURGICAL INSTRUMENTS

CARDIOVASCULAR



DeBakey
AS-9-149-16
Vascular Forceps
16 cm,



DeBakey
AS-9-150-16
Vascular Forceps
16 cm,



DeBakey
AS-9-151-16
Vascular Forceps
16 cm,

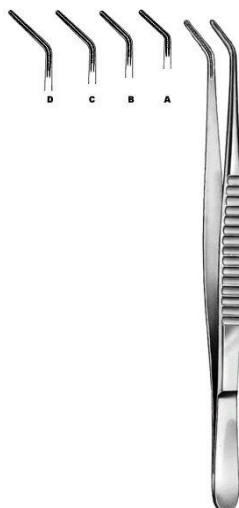

DeBakey
AS-9-152-16
Vascular Forceps
16 cm,



DeBakey
AS-9-153-16
Vascular Forceps
16 cm,



DeBakey
AS-9-154-07
Bulldog Clamp
7.5 cm,

SURGICAL INSTRUMENTS

CARDIOVASCULAR



DeBakey
AS-9-155-07
Bulldog Clamp
7.5 cm,



AS-9-156-23
Applying Forceps
23.5 cm,

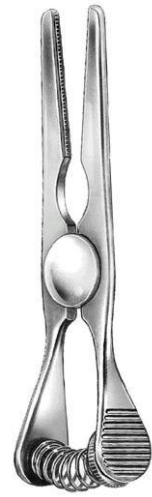

Glover
AS-9-157-06
Bulldog Clamp
7 cm,



Glover
AS-9-158-06
Bulldog Clamp
6.5 cm,

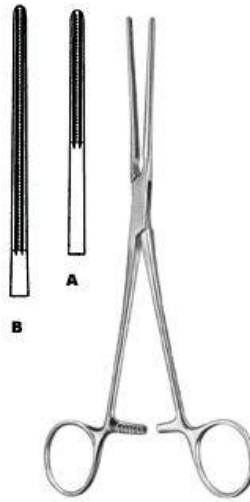

Potts
AS-9-159-21
Coarctation Clamp
21 cm,

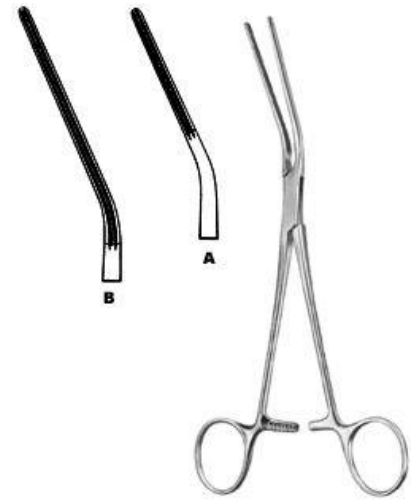

Potts
AS-9-160-21
Coarctation Clamp
20.5 cm,

SURGICAL INSTRUMENTS

CARDIOVASCULAR

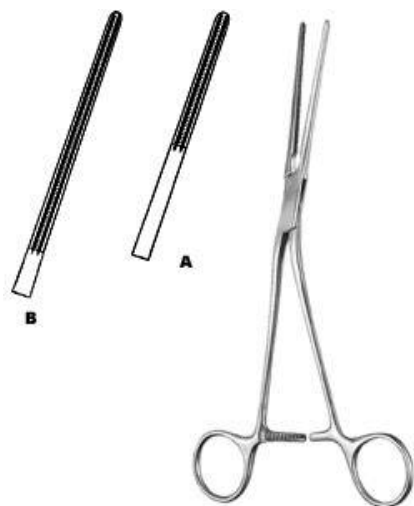

Potts
AS-9-161-21
Coarctation Clamp
20.5 cm,



Potts
AS-9-162-22
Anastomosis Clamp
21.5 cm,



Potts
AS-9-163-22
Anastomosis Clamp
22 cm,

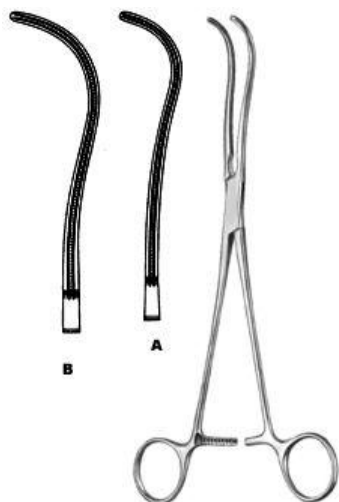

DeBakey
AS-9-164-19
Ligature Forceps
19 cm,



DeBakey
AS-9-165-16
Peripheral Vascular Clamp
16 cm,



DeBakey
AS-9-166-19
Peripheral Vascular Clamp
16 cm,

SURGICAL INSTRUMENTS

CARDIOVASCULAR

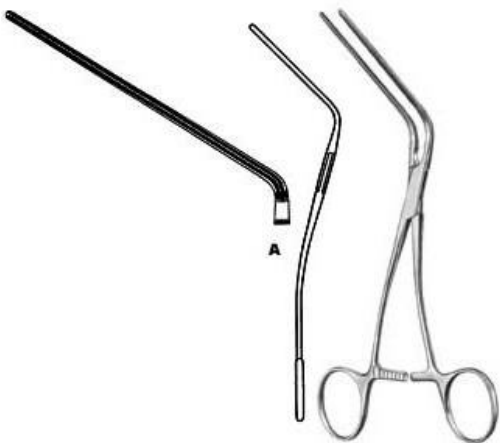

Leland-Jones
AS-9-167-18
Peripheral Vascular Clamp
18 cm,



Bainbridge
AS-9-168-15
Multi purpose Vascular Clamp
15 cm,

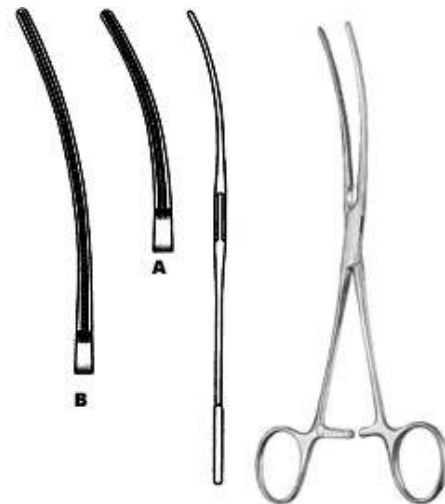

Bainbridge
AS-9-169-15
Multi purpose Vascular Clamp
15 cm,

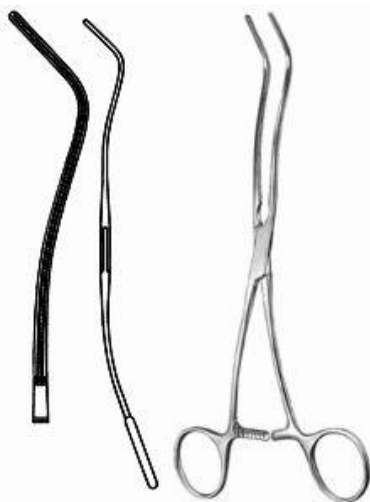

DeBakey
AS-9-170-20
Multi purpose Vascular Clamp
20 cm,



DeBakey
AS-9-171-26
Aortic Aneurysm Clamp
26 cm,



DeBakey
AS-9-172-28
Aortic Aneurysm Clamp
28 cm,

SURGICAL INSTRUMENTS

CARDIOVASCULAR



DeBakey
AS-9-173-30
Aortic Aneurysm Clamp
30 cm,



DeBakey
AS-9-174-27
Aortic Clamp
27 cm,



DeBakey
AS-9-175-24
Ligature Forceps
24.5 cm,



DeBakey
AS-9-176-24
Ligature Forceps
24.5 cm,

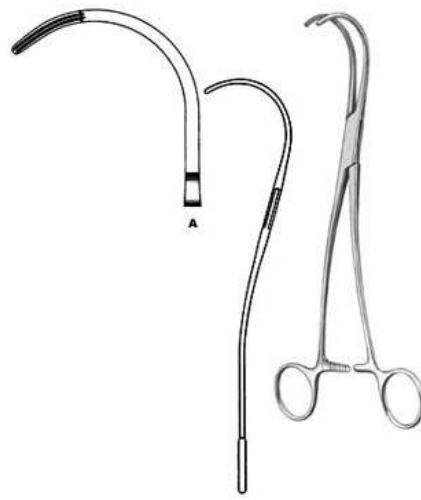

DeBakey
AS-9-178-25
Ligature Forceps
27 cm,

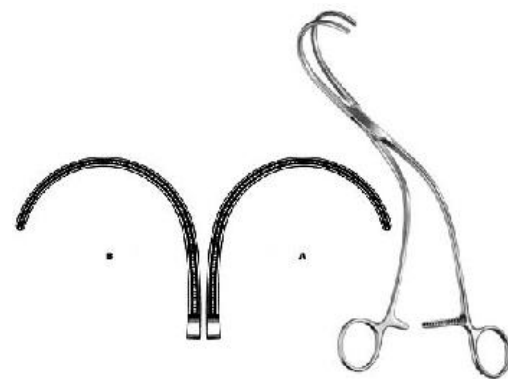

Weber
AS-9-179-01
Aortic Clamp
24 cm,

SURGICAL INSTRUMENTS

CARDIOVASCULAR



Satinsky
AS-9-180-20
Tangential Occlusion Clamp
22 cm,



Harken
AS-9-181-01
Auricle Clamp
24.5 cm,



Lees
AS-9-182-23
Bronchus Clamp
23 cm,



Lees
AS-9-183-25
Bronchus Clamp
25 cm,



Lambert-Kay
AS-9-184-21
Anastomosis Clamp
22.5 cm,



DeBakey
AS-9-185-17
Anastomosis Clamp
16.5 cm,

SURGICAL INSTRUMENTS

CARDIOVASCULAR



Morris-DeBakey
AS-9-186-18
Aortic Clamp
16.5 cm,



DeBakey-Bahnson
AS-9-187-23
Aneurysm Clamp
23.5 cm,

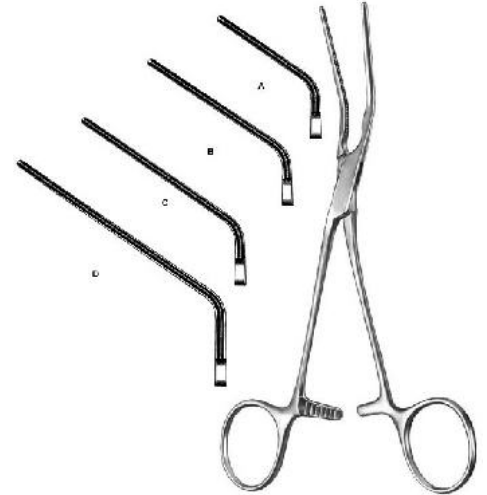

DeBakey
AS-9-188-20
Multi purpose Vascular Clamp
18 cm,

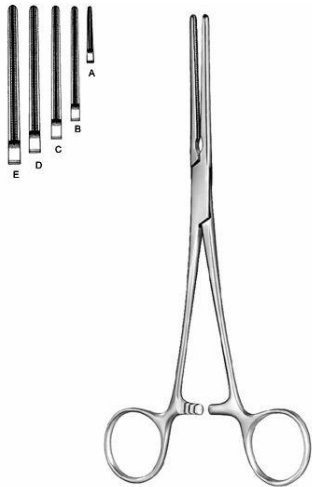

DeBakey-Mosquito
AS-9-189-12
Haemostatic Forceps
12.5 cm,



DeBakey-Mosquito
AS-9-190-12
Haemostatic Forceps
12.5 cm,



DeBakey
AS-9-191-17
Multi purpose Vascular Clamp
17 cm,

SURGICAL INSTRUMENTS

CARDIOVASCULAR



DeBakey
AS-9-192-16
Multi purpose Vascular Clamp
16.5 cm,

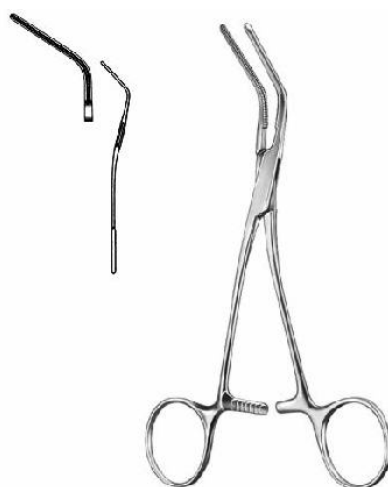

DeBakey
AS-9-193-15
Multi purpose Vascular Clamp
16 cm,



DeBakey
AS-9-194-15
Multi purpose Vascular Clamp
16.5 cm,



DeBakey
AS-9-195-17
Multi purpose Vascular Clamp
16.5 cm,



Glover
AS-9-196-17
Multi purpose Vascular Clamp
17 cm,



Glover
AS-9-197-17
Multi purpose Vascular Clamp
17.5 cm,

SURGICAL INSTRUMENTS

CARDIOVASCULAR

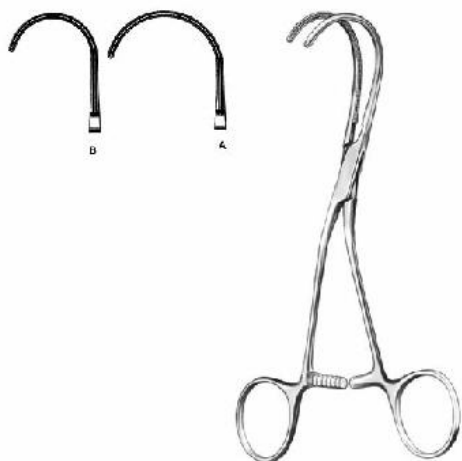

DeBakey
AS-9-198-16
Multi purpose Vascular Clamp
16.5 cm,

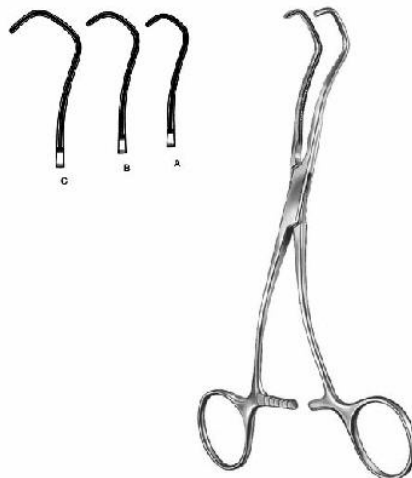

Derra
AS-9-199-16
Anastomosis Clamp
16.5 cm Fig. 1, 17 cm Fig. 2, 18 cm Fig. 3,



DeBakey-Beck
AS-9-200-17
Anastomosis Clamp
17 cm,



Cooley
AS-9-201-16
Vascular Forceps
16 cm,

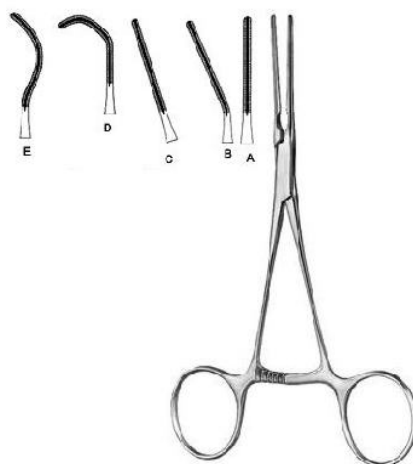

Cooley
AS-9-202-01
Pediatric Vascular Clamp
14.5 cm,



Cooley
AS-9-203-21
Iliac Clamp
22 cm,

SURGICAL INSTRUMENTS

CARDIOVASCULAR



Cooley
AS-9-204-17
Anastomosis Clamp
17 cm,

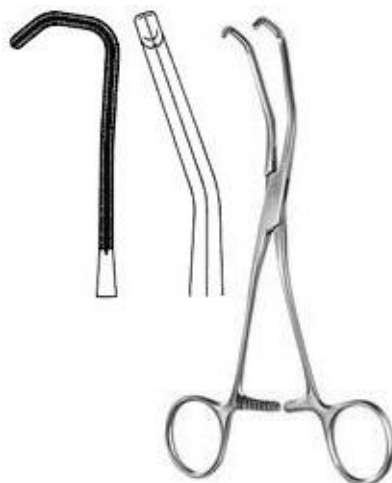

Cooley
AS-9-205-17
Anastomosis Clamp
20 cm,



Cooley
AS-9-206-16
Anastomosis Clamp
17 cm,



Cooley
AS-9-207-15
Multi purpose Vascular Clamp
16 cm,



Cooley
AS-9-208-17
Multi purpose Vascular Clamp
17 cm,



Cooley
AS-9-209-17
Multi purpose Vascular Clamp
17 cm,

SURGICAL INSTRUMENTS

CARDIOVASCULAR



Cooley
AS-9-210-17
Multi purpose Vascular Clamp
17.5 cm,

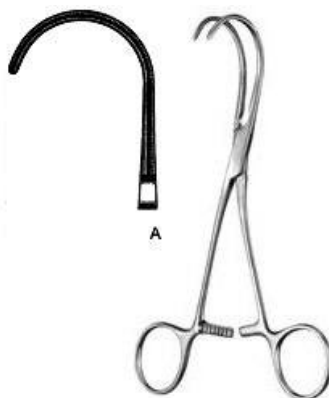

Cooley
AS-9-211-16
Multi purpose Vascular Clamp
16.5 cm,



Cooley-Derra
AS-9-212-16
Anastomosis Clamp
16.5 cm,



Cooley-Beck
AS-9-213-17
Anastomosis Clamp
17 cm,

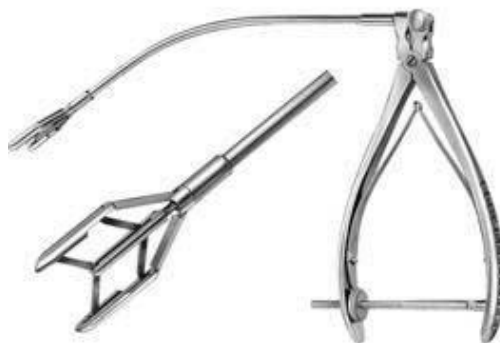

Cooley
AS-9-214-00
Aortic Dilator

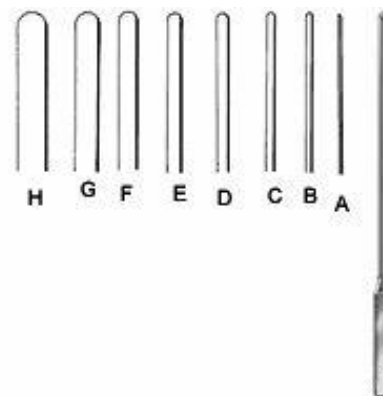

Cooley
AS-9-215-05
Vascular Dilator
13 cm 0,5 mm ?,

SURGICAL INSTRUMENTS

CARDIOVASCULAR



DeBakey
AS-9-216-05
Vascular Dilator
19 cm 0,5 mm ?,



Martin
AS-9-217-00
Tunneling Set complete set with three
shafts, two handles and 12 tips in storage
case.



Hach
AS-9-218-01
Fasciotomy Knife with plastic handle
30 cm,



AS-9-219-18
Intima Spatula
18.5 cm,

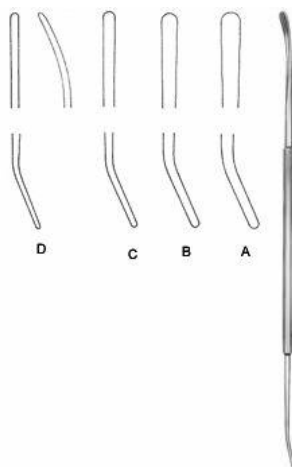

Robb
AS-9-220-01
Vascular Dissector
24 cm Fig. 1 2,5 mm ?, 24 cm Fig. 2 2,0 mm
?,



Crile
AS-9-221-20
Nerve Hooklet
20 cm,

SURGICAL INSTRUMENTS

CARDIOVASCULAR

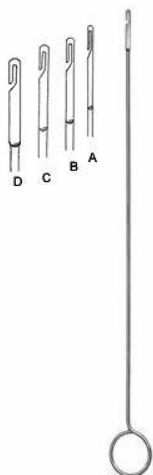

AS-9-222-15
Ligature Catcher
26 cm 1,5 mm,



Subramanian-Miniature
AS-9-223-15
Aortic Clamp 135 degree
15.5 cm,

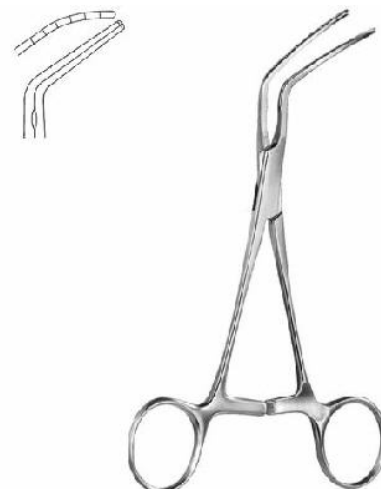

Subramanian
AS-9-224-16
Aortic Clamp
16 cm,

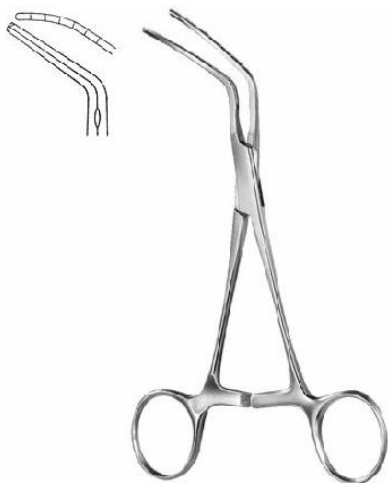

Subramanian
AS-9-225-16
Aortic Clamp
13.5 cm Fig. 1, 13.5 cm Fig. 2, 14 cm Fig. 3,

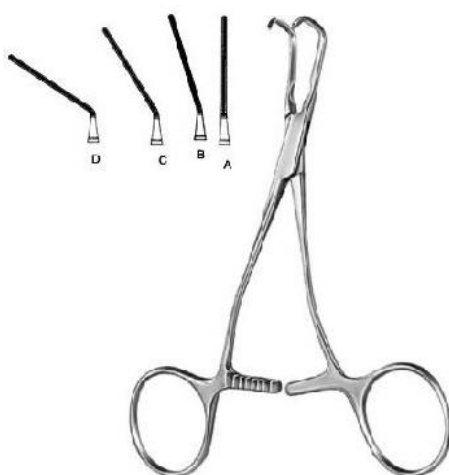

AS-9-226-01
Pediatric Vascular Clamp



AS-9-227-16
Pediatric Vascular Clamp
16.5 cm,

SURGICAL INSTRUMENTS

CARDIOVASCULAR



AS-9-228-16
Pediatric Vascular Clamp
16 cm,

SURGICAL INSTRUMENTS

OPHTHALMOLOGY



Barraquer (Colibri)
AS-11-101-03
Barraquer
Size 1,

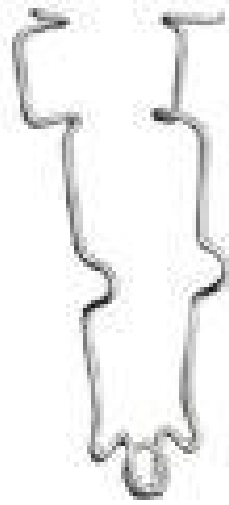

AS-11-102-07
Bowman
Size 1,



AS-11-103-06
Critchett
Size 1,



AS-11-104-05
Smith
Size 1,

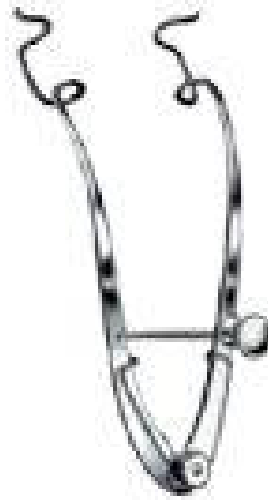

AS-11-105-08
Clark
Size 1,



AS-11-106-06
Graefe
Size 1,

SURGICAL INSTRUMENTS

OPHTHALMOLOGY



AS-11-107-08
Week
Size 1,



AS-11-108-07
Arruga
Size 1,



AS-11-109-07
Arruga
Size 1,



AS-11-110-05
Murdock
Size 1,



Millenger
AS-11-111-07
Mellinger Axenfeld
Size 1,



Millenger
AS-11-112-07
Mellinger Axenfeld
Size 1,

SURGICAL INSTRUMENTS

OPHTHALMOLOGY



Millenger
AS-11-113-07
Mellinger
Size 1,



AS-11-114-08
Lister Burch
Size 1,



Williams Eye Speculum
AS-11-115-08
Williams
7 cm, 8.3 cm,



Lancaster
AS-11-116-07
Lancaster
Size 1,



AS-11-118-08
Ziegler
Size 1,



Mueller
AS-11-120-07
Mueller
Size 1,

SURGICAL INSTRUMENTS

OPHTHALMOLOGY



Jaeger Lid Plate
AS-11-121-11
Jaeger
4", 20mm, 23mm,



VON GRAEFE Knife
AS-11-122-03
Graefe
1, 2, 3, 4, 5,



AS-11-123-01
Jaeger
Size 1,



AS-11-124-13
Berens
Size 1,

ZIEGLER knife Needle
AS-11-126-01
Ziegler
11.4 cm,



Castroviejo Cyclodialysis Spatula
AS-11-127-12
Castroviejo
13.3 cm,

SURGICAL INSTRUMENTS

OPHTHALMOLOGY



AS-11-128-12
Wheeler
Size 1,



Castroviejo Cyclodialysis Spatula
AS-11-129-05
Castroviejo
Size 1,



AS-11-130-12
Dix
Size 1,



AS-11-131-13
Dix
Size 1,



AS-11-132-13
Dix
Size 1,



Castroviejo Caliper
AS-11-133-07
Castroviejo
8.3 cm,

SURGICAL INSTRUMENTS

OPHTHALMOLOGY



AS-11-134-13
Connin Amsler
Size 1,



AS-11-135-06
Dastoor
Size 1,



AS-11-136-09
Holth
Size 1,



Wilder Lacrimal Dilator
AS-11-137-03
Wilder
10.2 cm,



ZIEGLER Lacrimal Dilator
AS-11-138-12
Ziegler
14 cm Double End,



Castroviejo Lacrimal Dilator
AS-11-139-12
Castroviejo
14 cm,

SURGICAL INSTRUMENTS

OPHTHALMOLOGY



AS-11-140-78
Bowman
Size 1,



AS-11-141-07
Graefe
Size 1,



AS-11-142-07
Graefe
Size 1,



AS-11-143-07
Graefe
Size 1,



AS-11-144-07
Graefe
Size 1,



AS-11-145-07
Fischer
Size 1,

SURGICAL INSTRUMENTS

OPHTHALMOLOGY



AS-11-146-07
Barraquer Katzin
Size 1,



AS-11-147-07
Troutman
Size 1,



AS-11-148-07
Barraquer
Size 1,



AS-11-149-07
Barraquer
Size 1,



AS-11-150-09
McCullough
Size 1,



AS-11-151-09
McCullough
Size 1,

SURGICAL INSTRUMENTS

OPHTHALMOLOGY



AS-11-152-10
Jameson
Size 1,



AS-11-153-10
Jameson
Size 1,



AS-11-154-10
Bonaccolto
Size 1,



AS-11-155-10
Bonaccolto
Size 1,



AS-11-156-10
Dastoor
Size 1,



AS-11-157-10
Dastoor
Size 1,

SURGICAL INSTRUMENTS

OPHTHALMOLOGY



AS-11-158-05
Bishop Harman
Size 1,



AS-11-159-08
Bishop Harman
Size 1,



AS-11-160-05
Bishop Harman
Size 1,



AS-11-161-08
Bishop Harman
Size 1,



AS-11-162-07
Mod Bonn
Size 1,



AS-11-163-07
Mod Bonn
Size 1,

SURGICAL INSTRUMENTS

OPHTHALMOLOGY



AS-11-164-10
Mod Bonn
Size 1,



AS-11-165-10
Mod Bonn
Size 1,



AS-11-166-10
Mod Bonn
Size 1,



AS-11-167-10
Mod Bonn
Size 1,



AS-11-168-10
Prince
Size 1,



AS-11-169-10
Prince
Size 1,

SURGICAL INSTRUMENTS

OPHTHALMOLOGY



AS-11-170-20
Berke
Size 1,



AS-11-171-08
Troutman
Size 1,



AS-11-172-05
Barrquer
Size 1,



AS-11-173-11
Elsching
Size 1,



AS-11-174-11
Graefe
Size 1,



AS-11-175-09
Lester
Size 1,

SURGICAL INSTRUMENTS

OPHTHALMOLOGY



AS-11-176-09
Castroviejo
Size 1,



AS-11-178-09
Castroviejo
Size 1,



AS-11-179-09
Barraquer
Size 1,



AS-11-180-10
Green
Size 1,



AS-11-181-07
Gill Arruga
Size 1,



AS-11-182-01
Castroviejo
Size 1,

SURGICAL INSTRUMENTS

OPHTHALMOLOGY



AS-11-183-05
Castroviejo
Size 1,



AS-11-184-10
Moorfield
Size 1,



AS-11-185-07
St Martin
Size 1,



AS-11-186-10
Mod Tubingen
Size 1,



AS-11-187-10
McPherson
Size 1,



AS-11-188-10
McPherson
Size 1,

SURGICAL INSTRUMENTS

OPHTHALMOLOGY



AS-11-189-09
Ayer
Size 1,



AS-11-190-09
Ayer
Size 1,



AS-11-191-09
Desmarres
Size 1,



AS-11-192-10
Snellen
Size 1,



AS-11-1193-11
Knapp Luer
Size 1,



AS-11-194-28
Scheie
Size 1,

SURGICAL INSTRUMENTS

OPHTHALMOLOGY



AS-11-195-45
Mod Tubingen
Size 1,



AS-11-196-00
Elliot
Size 1,

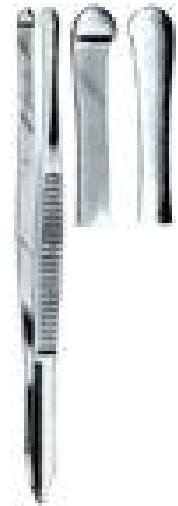

AS-11-197-09
Beer
Size 1,

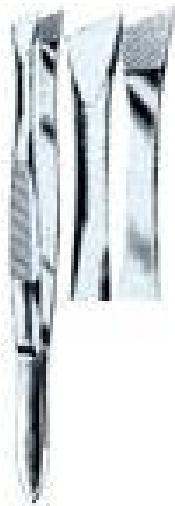

AS-11-198-10
Barraquer

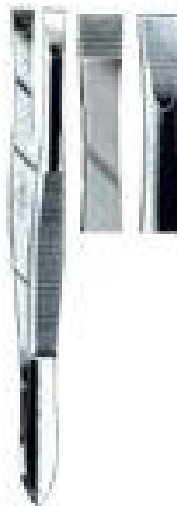

AS-11-199-09
Douglas
Size 1,



AS-11-200-09
Gradle
Size 1,

SURGICAL INSTRUMENTS

TRACHEOTOMY

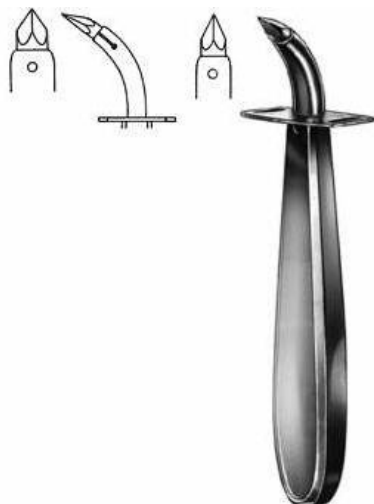

Ueckermann
AS-16-101-13
Tracheotomy Trocar
11.5 cm,



Iterson
AS-16-102-16
Tracheal Hook
17 cm,



Rose
AS-16-103-13
Tracheal Hook
13.5 cm,



Luer
AS-16-104-11
Tracheal Hook
11 cm,

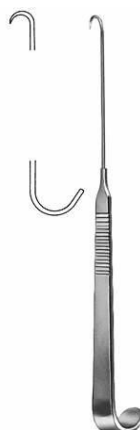

AS-16-105-15
Tracheal Hook
15 cm,



Lukens
AS-16-106-17
Thymus Retractor
17.5 cm,

SURGICAL INSTRUMENTS

TRACHEOTOMY



Jackson
AS-16-107-17
Tracheal Hook
18 cm,



Kocher
AS-16-108-15
Goitre Enucleator
16.5 cm,



Kocher
AS-16-109-15
Goitre Enucleator
16.5 cm,



Hofmeister
AS-16-110-21
Goitre Enucleator
20.5 cm,

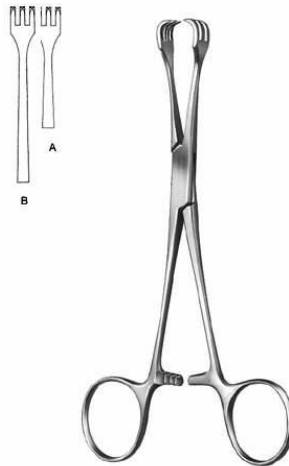

Lahey
AS-16-111-15
Goitre Grasping Forceps
15.5 cm,



Luer
AS-16-112-04
Tracheal Tube

SURGICAL INSTRUMENTS

TRACHEOTOMY



Luer
AS-16-113-08
Tracheal Tube



Chevalier-Jackson
AS-16-114-04
Tracheal Tube outer tube closed inner tube
closed silver



AS-16-115-08
Speaking Tube

SURGICAL INSTRUMENTS

DERMATOLOGY



Moncorps
AS-17-101-14
Milium Knife
14 cm,



Moncorps
AS-17-102-00
Spare Blade



Vidal
AS-17-103-14
Lupus Scraper
13 cm,



Wolff
AS-17-105-01
Lupus Curette
14 cm,



Kilner
AS-17-106-15
Skin Hooklet
14.5 cm,



Gillies
AS-17-107-18
Skin Hooklet
18 cm,

SURGICAL INSTRUMENTS

DERMATOLOGY



Kaye
AS-17-108-03
Face-lift Hook
13 cm,

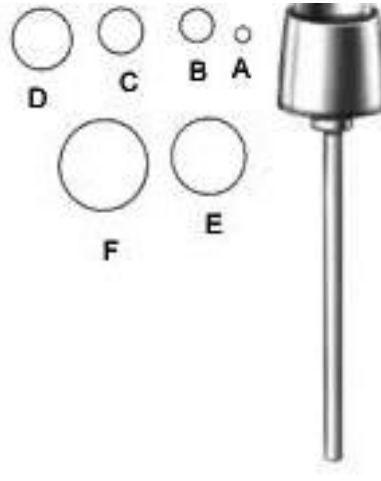

AS-17-109-02
Dermal Punch
5.5 cm,



Handle
AS-17-110-00
8 cm,

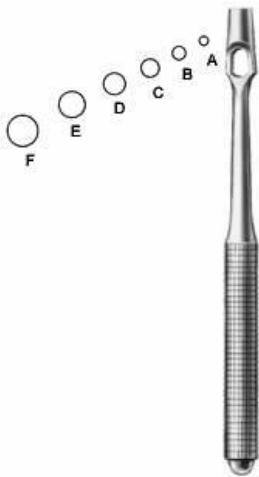

Keyes
AS-17-111-02
Dermal Punch
11 cm,



Unna
AS-17-113-14
Comedone Extractor
14.5 cm,



Saalfeld
AS-17-114-10
Comedone Extractor
11 cm,

SURGICAL INSTRUMENTS

DERMATOLOGY



Saalfeld
AS-17-115-14
Saalfeld Comedone Extractor
14.5 cm,



Schamberg
AS-17-116-10
Comedone Extractor
9.5 cm,



Katsch
AS-17-117-14
Comedone Extractor
16 cm,



Unna-Vidal
AS-17-118-11
Comedone Extractor
11.5 cm,



d'Assump?
AS-17-119-15
Face-lift Forceps
18 cm,



Gregory
AS-17-120-14
Face-lift Scissors
14 cm,

SURGICAL INSTRUMENTS

DERMATOLOGY

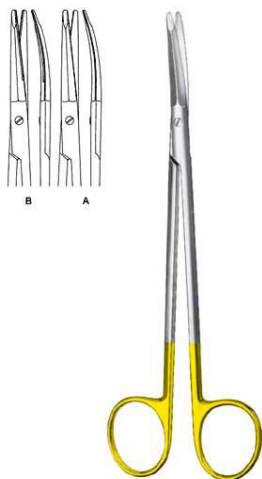

Kaye
AS-17-121-15
Face-lift Scissors
15 cm, 18 cm,



Stella-S
AS-17-122-18
Face-lift Scissors
18 cm,

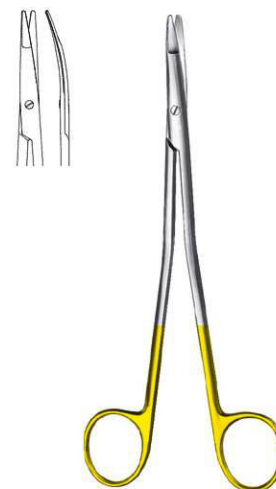

Gorney
AS-17-123-18
Face-lift Scissors
18 cm,

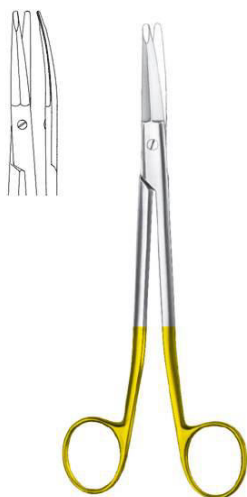

Freeman-Kaye
AS-17-124-18
Face-lift Scissors
18 cm,

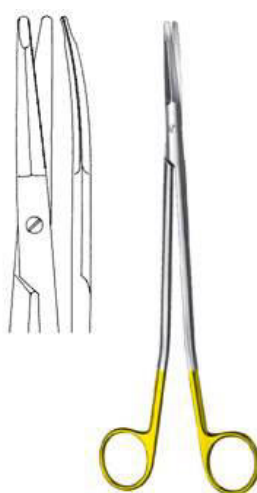

Freeman
AS-17-125-00
Face-lift Scissors
23 cm,



Fox
AS-17-104-01
Lupus Curette
14 cm,

SURGICAL INSTRUMENTS

DERMATOLOGY

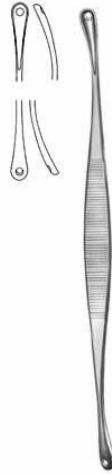

Unna
AS-17-112-14
Comedone Extractor
14.5 cm,

SURGICAL INSTRUMENTS

INTESTINES & STOMACH



Allis-Baby
AS-18-101-12

Intestinal and Tissue Grasping Forceps
13 cm,

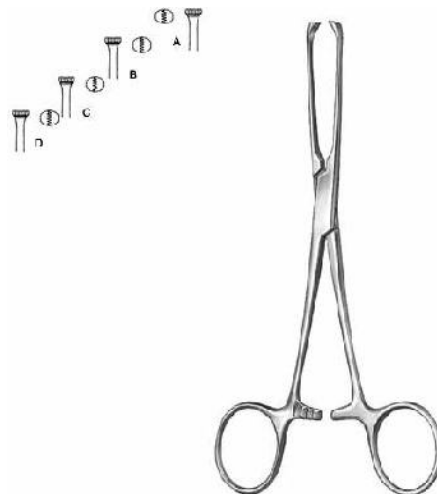

Allis
AS-18-102-15

Intestinal and Tissue Grasping Forceps
15.5 cm, 19 cm, 25.5 cm,

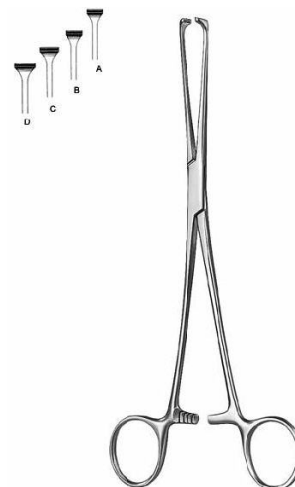

Allis
AS-18-103-16

Intestinal and Tissue Grasping Forceps
15.5 cm, 20 cm, 24.5 cm, 30 cm,

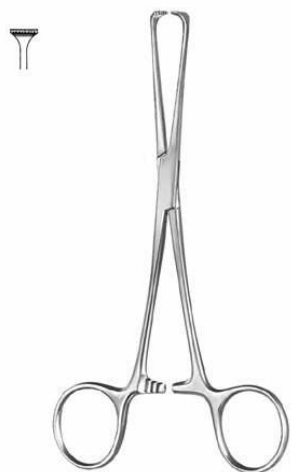

Allis-Adair
AS-18-104-15

Intestinal and Tissue Grasping Forceps
16 cm,



Boys-Allis
AS-18-105-15

Intestinal and Tissue Grasping Forceps
15.5 cm,



Thoms-Allis
AS-18-106-20

Intestinal and Tissue Grasping Forceps
20.5 cm,

SURGICAL INSTRUMENTS

INTESTINES & STOMACH



Allis
AS-18-107-20

Intestinal and Tissue Grasping Forceps
20 cm,

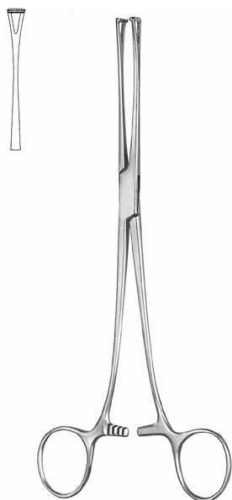

Lockwood
AS-18-108-20

Intestinal and Tissue Grasping Forceps
20 cm,

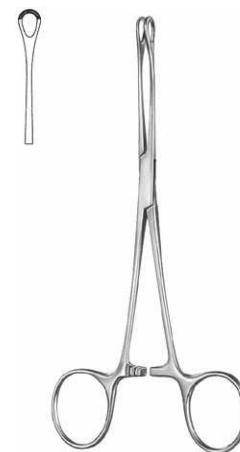

Williams
AS-18-109-16

Intestinal and Tissue Grasping Forceps
16.5 cm,

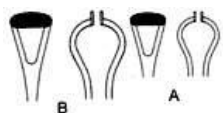

Babcock
AS-18-110-16

Intestinal and Tissue Grasping Forceps
16.5 cm, 21 cm,

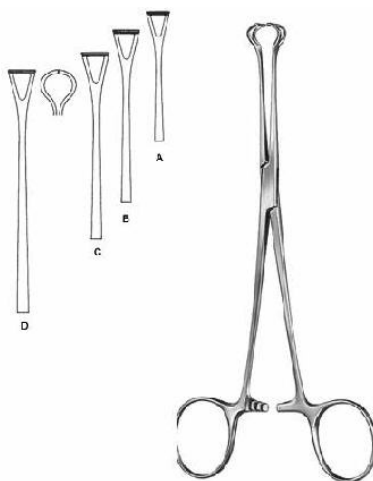

Babcock
AS-18-111-16

Intestinal and Tissue Grasping Forceps
15.5 cm, 17.5 cm, 21 cm, 24 cm,

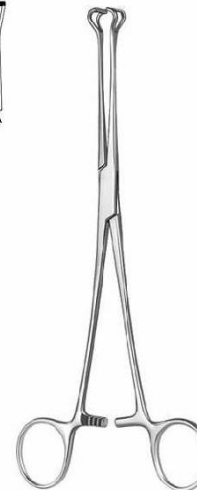

Babcock
AS-18-112-16

Intestinal and Tissue Grasping Forceps
16 cm, 20.5 cm,

SURGICAL INSTRUMENTS

INTESTINES & STOMACH



Duval
AS-18-113-20

Intestinal and Tissue Grasping Forceps
20.5 cm,

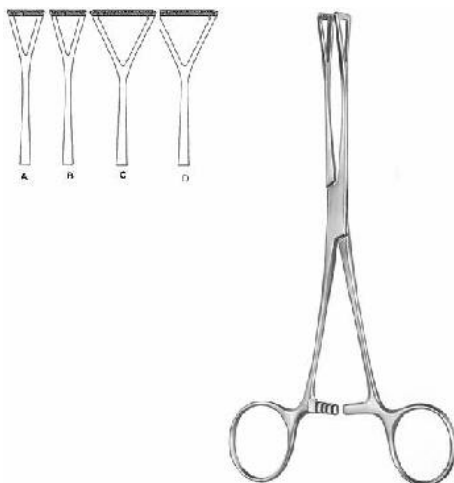

Duval
AS-18-114-18

Intestinal and Tissue Grasping Forceps
18 cm, 20.5 cm, 23 cm,

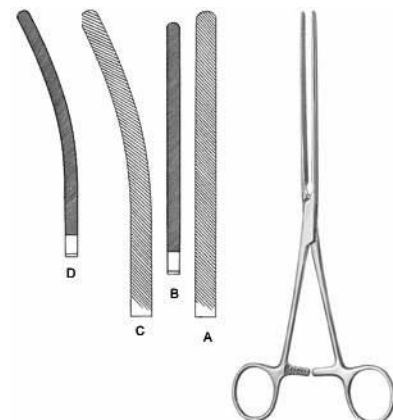

Doyen

AS-18-115-21

Intestinal Clamp
21.5 cm, 23.5 cm,



Doyen-Baby
AS-18-116-18

Intestinal Clamp
18 cm, 17.5 cm,

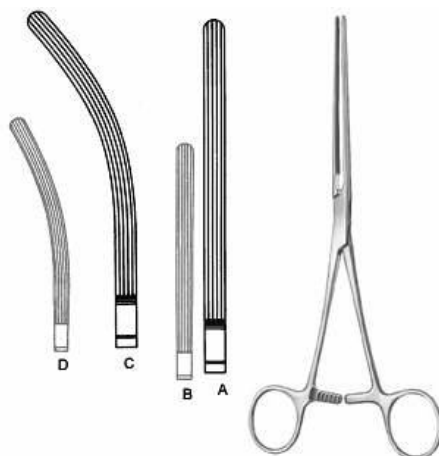

Mayo-Robson
AS-18-117-21

Intestinal Clamp
21.5 cm, 23.5 cm, 23 cm,

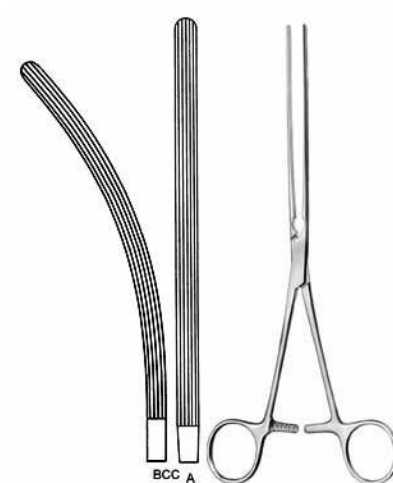

Mayo-Robson
AS-18-118-25

Intestinal Clamp
25.5 cm, 24.5 cm,

SURGICAL INSTRUMENTS

INTESTINES & STOMACH

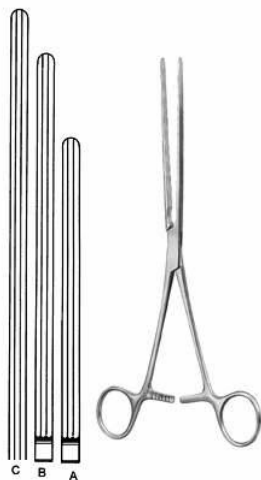

Kocher
AS-18-119-22
Intestinal Clamp
22.5 cm, 25 cm, 28.5 cm,

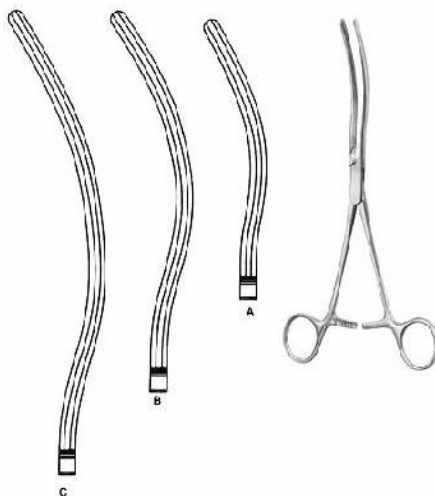

Kocher
AS-18-120-22
Intestinal Clamp
22 cm, 24.5 cm, 27.5 cm,



Allen
AS-18-121-16
Intestinal Clamp
16 cm,



Payr-Baby
AS-18-122-15
Intestinal and Pylorus Clamp
15 cm,

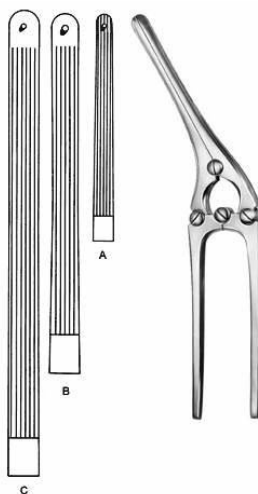

Payr
AS-18-123-21
Intestinal and Pylorus Clamp
20.5 cm, 29 cm, 34.5 cm,



Stone-Watt
AS-18-124-07
Intestinal Anastomosis Clamp
8.5 cm, 10 cm,

SURGICAL INSTRUMENTS

INTESTINES & STOMACH



Stone-Watt
AS-18-125-15
Closing Forceps

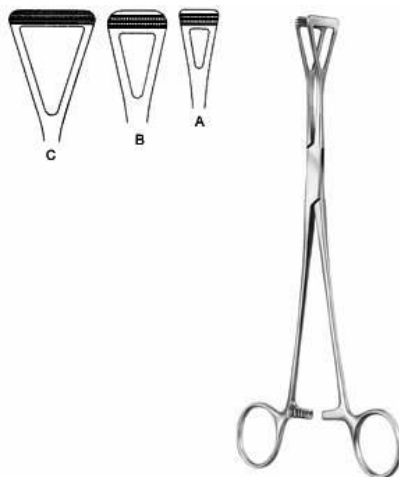

Scheibe
AS-18-126-18
Organ Grasping Forceps
18 cm,

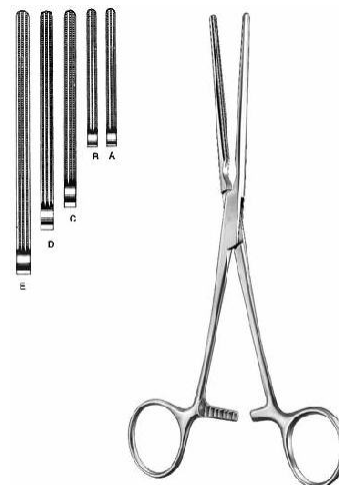

Doyen-Baby
AS-18-127-13
Intestinal Clamp
14 cm, 17 cm,

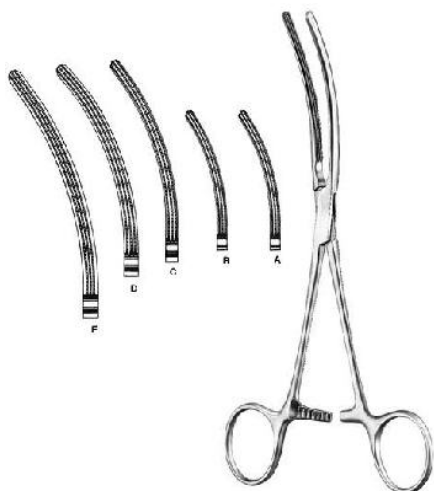

Doyen-Baby
AS-18-128-13
Intestinal Clamp
13.5 cm, 17 cm,



Mayo-Robson
AS-18-129-25
Intestinal Clamp
26 cm,



Mayo-Robson
AS-18-130-25
Intestinal Clamp
25 cm,

SURGICAL INSTRUMENTS

INTESTINES & STOMACH

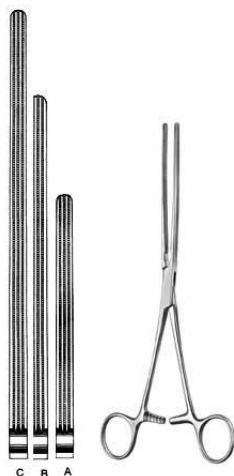

Kocher
AS-18-131-22
Intestinal Clamp
22.5 cm, 28 cm,

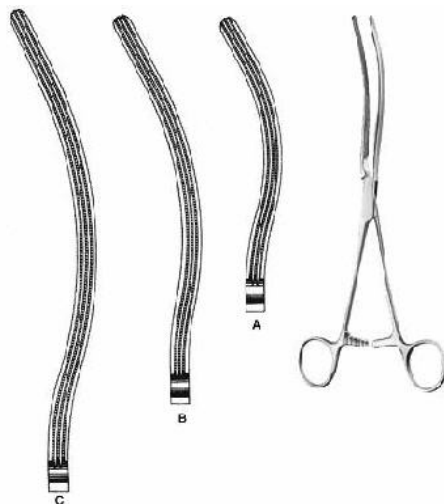

Kocher
AS-18-132-22
Intestinal Clamp
22 cm, 25 cm, 27.5 cm,

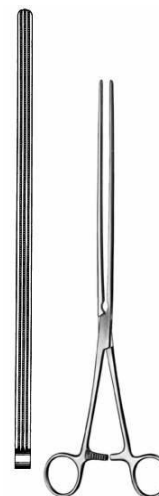

Scudder
AS-18-133-33
Intestinal Clamp
33.5 cm,

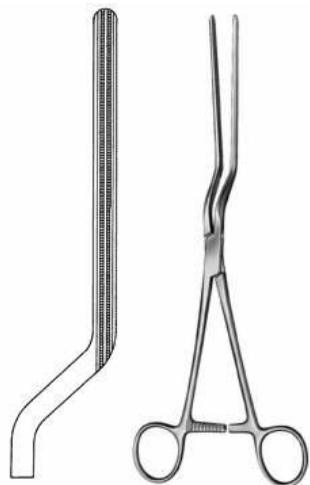

Brunner
AS-18-134-24
Sigmoid Anastomosis Forceps
27 cm,

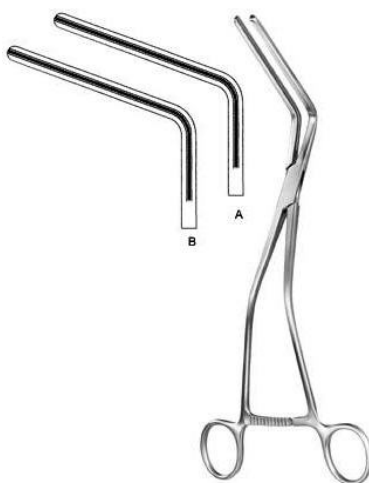

Hayes
AS-18-135-26
Sigmoid Anastomosis Forceps
27 cm, 28 cm,



Veidenheimer
AS-18-136-23
Sigmoid Anastomosis Forceps
25 cm,

SURGICAL INSTRUMENTS

INTESTINES & STOMACH



Fehland
AS-18-137-24
Sigmoid Anastomosis Forceps
24 cm,

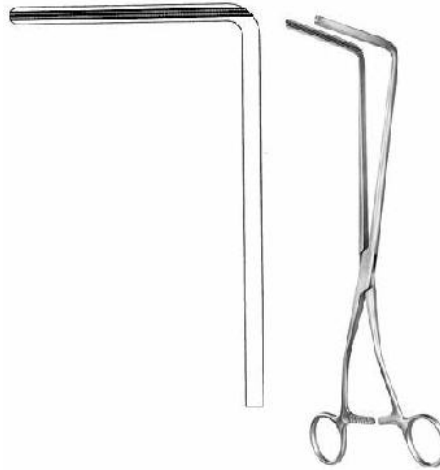

Resano
AS-18-138-30
Sigmoid Anastomosis Forceps
28 cm,



Sims
AS-18-139-15
Rectal Speculum
15.5 cm,



Sims
AS-18-140-15
Rectal Speculum
15.5 cm,



Mathieu
AS-18-141-19
Rectal Speculum
19 cm,



Alan-Parks
AS-18-142-00
Alan-Parks
14 cm,

SURGICAL INSTRUMENTS

INTESTINES & STOMACH

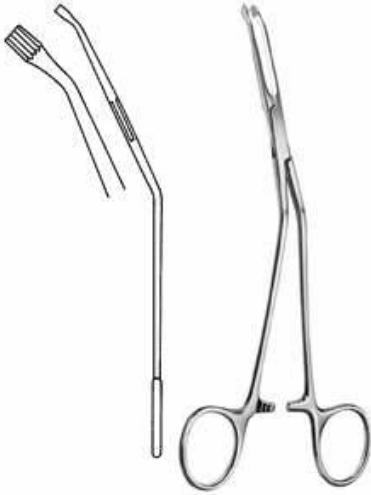

McGinvey

AS-18-143-19

Hemorrhoidal Grasping Forceps
19 cm,



AS-18-144-00

Handle for biopsy forceps

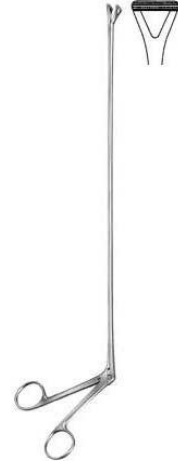

AS-18-145-38

Rectal Biopsy Forceps

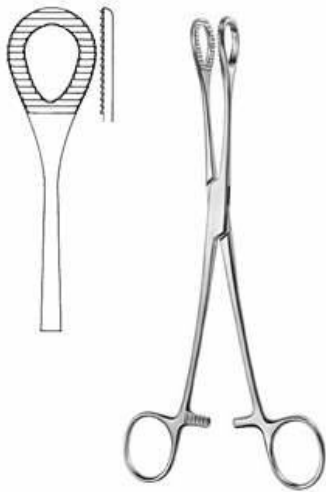

Heywood-Smith

AS-18-146-21

Polypus Grasping Forceps
21 cm,

SURGICAL INSTRUMENTS

UROLOGY

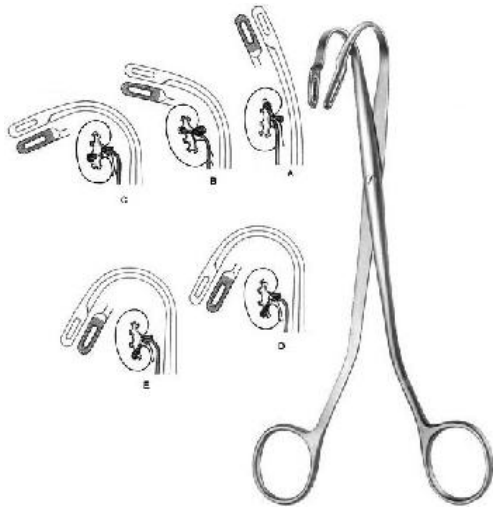

Randall
AS-19-101-23 A

Kidney Stone Forceps
23 cm Fig. 1, 21 cm Fig. 2, 19 cm Fig. 3,

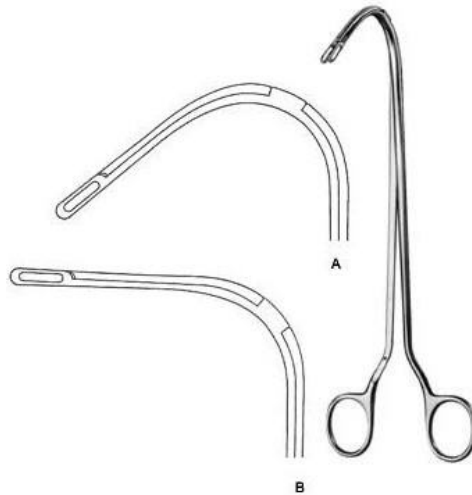

Randall
AS-19-102-23 A

Kidney Stone Forceps
23 cm, 24.5 cm,

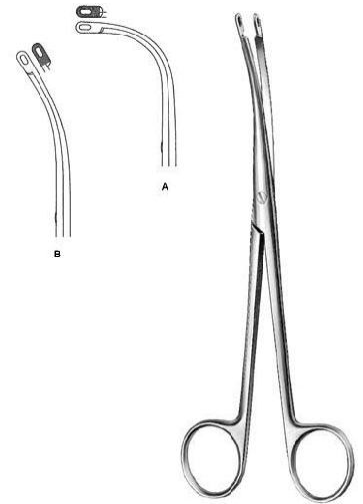

Heiming
AS-19-103-16 A

Kidney Stone Forceps
16 cm Fig. 1, 17 cm Fig. 2,

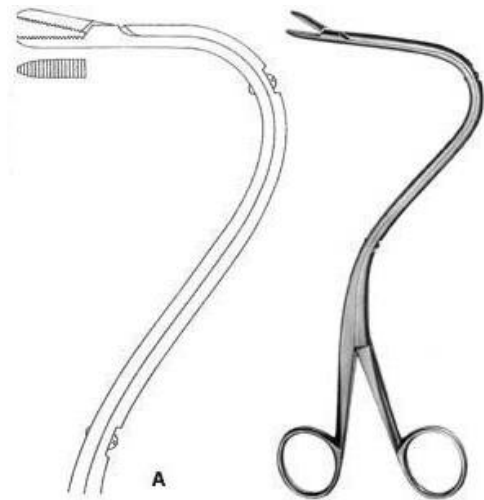

Elsasser
AS-19-104-01 A

Nephrostomy Forceps
21 cm Fig. 1, 21 cm Fig. 2,

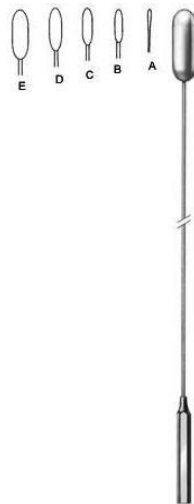

Bakes
AS-19-105-01 A

Gall Duct Dilator
32 cm,

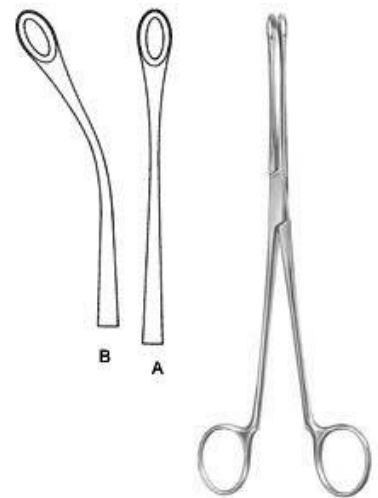

Blake
AS-19-106-20 A

Gall Stone Forceps
21 cm,

SURGICAL INSTRUMENTS

UROLOGY



Mayo-Blake
AS-19-107-20
Gall Stone Forceps
21 cm,



Mayo-Blake
AS-19-108-20
Gall Stone Forceps
21 cm,



Mixer
AS-19-109-22
Gall Stone Forceps
21.5 cm,



Desjardins
AS-19-110-23 A
Gall Stone Forceps
23 cm,

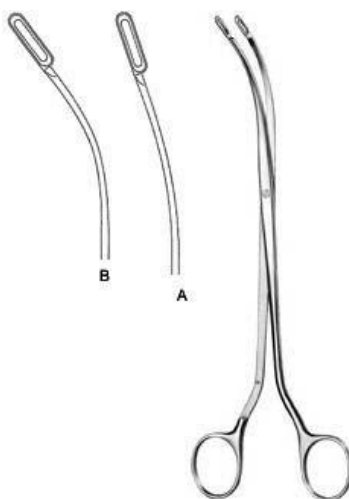

Desjardins
AS-19-111-24 A
Gall Stone Forceps



Luer-Korte
AS-19-112-01 A
Gall Stone Scoop
32 cm Fig. 0, 32 cm Fig. 00, 32 cm Fig. 000, 32 cm Fig. 1, 32 cm Fig. 2, 32 cm Fig. 3, 32 cm Fig. 4,

SURGICAL INSTRUMENTS

UROLOGY

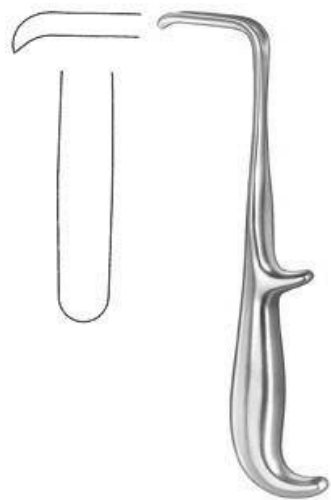

Young
AS-19-113-21
Prostatic Retractor
21.5 cm,



Young
AS-19-114-22
Prostatic Retractor
20.5 cm,



Young
AS-19-115-21
Prostatic Retractor
22 cm,

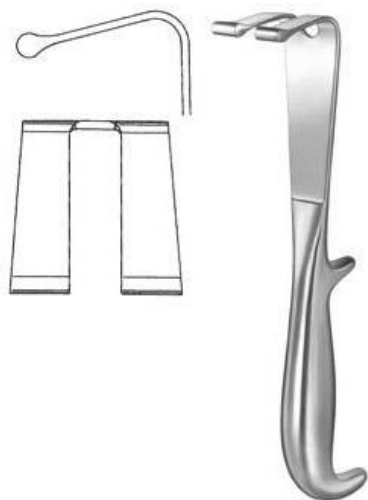

Young
AS-19-116-22
Prostatic Retractor
21.5 cm,



Millin
AS-19-117-24
Capsule Forceps
24.5 cm,

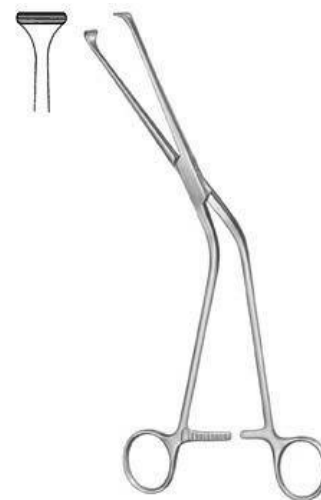

Millin
AS-19-118-24
Capsule Forceps
22 cm,

SURGICAL INSTRUMENTS

UROLOGY

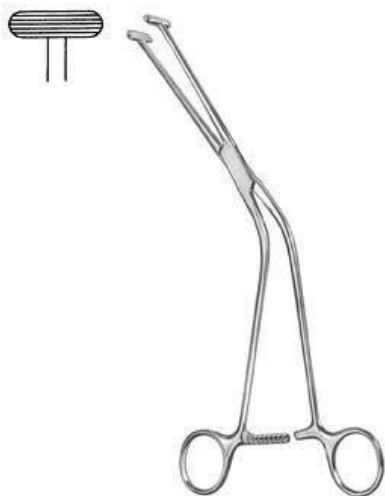

Millin
AS-19-119-23
Capsule Forceps
24.5 cm,

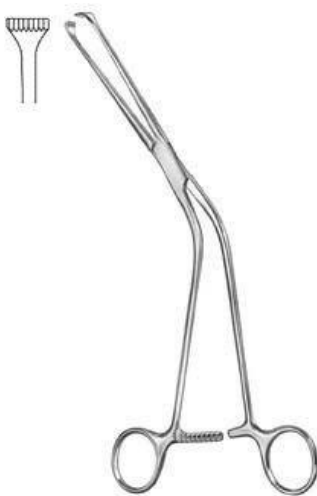

Millin
AS-19-120-23
Capsule Forceps
22 cm,

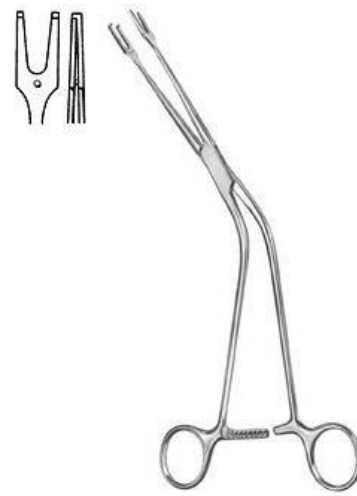

Millin
AS-19-121-24
Ligature Carrying Forceps
24.5 cm,



Millin
AS-19-122-00
Bladder Neck Spreader
29,



Thomson-Walker
AS-19-123-00
Bladder Retractor



Judd-Masson
AS-19-124-00
Bladder Retractor

SURGICAL INSTRUMENTS

UROLOGY



Millin
AS-19-125-00 A
Bladder Retractor



Legueu
AS-19-126-27
Bladder Spatula
24 cm 35 mm,

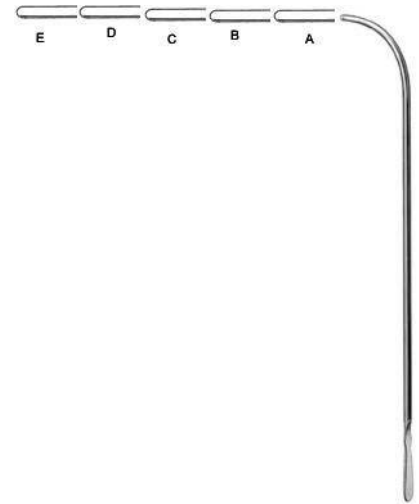

Van Buren
AS-19-127-00 A
Urethral Sound
27.5 cm,

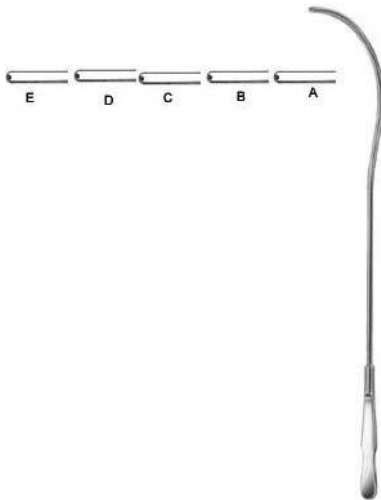

Guyon
AS-19-128-10 A
Urethral Sound
26 cm,

SURGICAL INSTRUMENTS

GYNECOLOGY



Cusco
AS-20-101
Vaginal Speculum
75 x 32 mm, 85 x 35 mm,



Cusco
AS-20-102-01
Vaginal Speculum
75 x 18 mm,



Cusco
AS-20-103-01
Vaginal Speculum
80 x 22 mm, 100 x 25 mm, 105 x 27 mm,



Cusco
AS-20-104-01
Vaginal Speculum
75 x 34 mm, 85 x 37 mm,



Collin
AS-20-105-01
Vaginal Speculum
85 x 30 mm, 100 x 35 mm,



Pederson
AS-20-106-01
Vaginal Speculum
75 x 13 mm, 100 x 22 mm,

SURGICAL INSTRUMENTS

GYNECOLOGY



Grave

AS-20-107-01

Vaginal Speculum
75 x 20 mm, 95 x 35 mm,



Semm

AS-20-108-01

Vaginal Speculum
100 x 20 mm, 105 x 27 mm,



Sims

AS-20-109-01

Vaginal Speculum
65 x 25 mm, 70 x 30 mm,



Kristeller

AS-20-110-01

Vaginal Speculum
70 x 27 mm,



Kristeller

AS-20-111-01

Vaginal Retractor
75 x 23 mm,



Kristeller

AS-20-112-01

Vaginal Speculum
Size 1,

SURGICAL INSTRUMENTS

GYNECOLOGY



Kristeller
AS-20-113-01
Vaginal Speculum
105 x 18 mm,



Kristeller
AS-20-114-01
Vaginal Retractor
110 x 14 mm,



Kristeller
AS-20-115-01
Vaginal Speculum
Size 1,

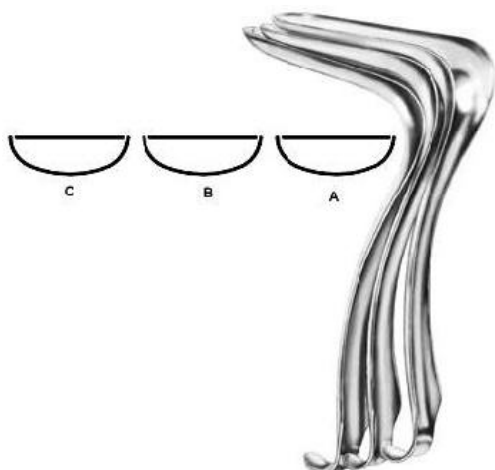

Kristeller
AS-20-116-01
Vaginal Speculum
105 x 26 mm,

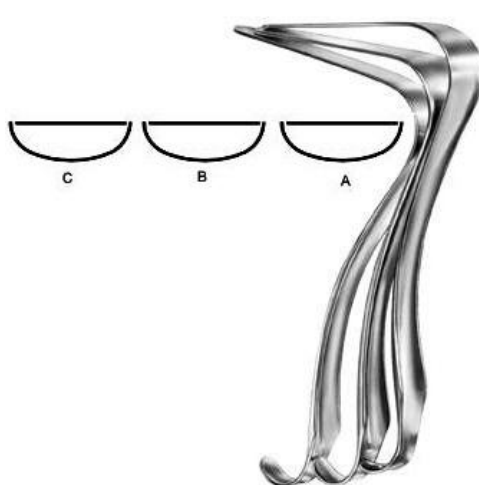

Kristeller
AS-20-117-01
Vaginal Retractor
115 x 22 mm, 115 x 24 mm,



Kristeller
AS-20-118-01
Vaginal Speculum
Size 1,

SURGICAL INSTRUMENTS

GYNECOLOGY

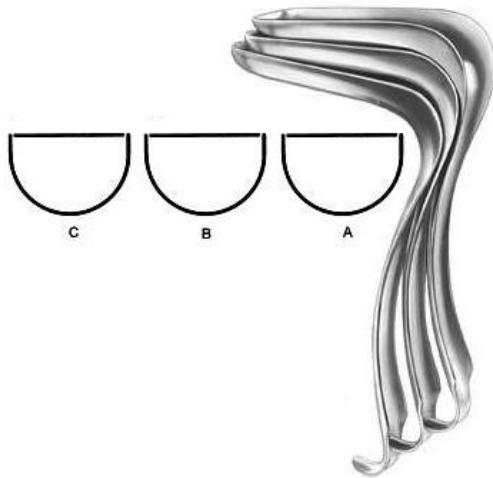

Kristeller
AS-20-119-01
Vaginal Speculum
110 x 27 mm,

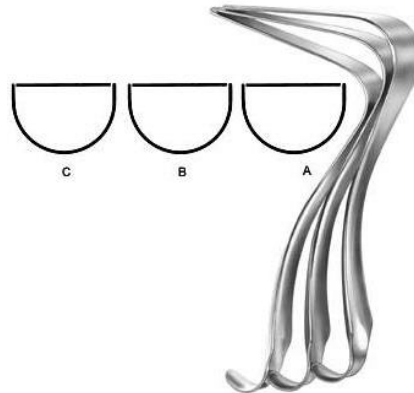

Kristeller
AS-20-120-01
Vaginal Retractor
115 x 23 mm,

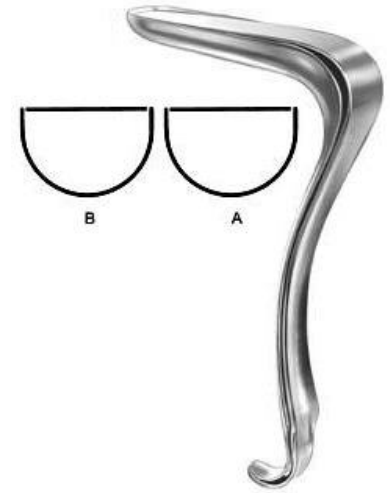

Kallmorgen
AS-20-121-01
Vaginal Speculum



Kallmorgen
AS-20-122-01
Vaginal Retractor
70 x 40 mm Fig. 1, 90 x 40 mm Fig. 2,



Kallmorgen
AS-20-123-01
Vaginal Speculum
70 x 33 mm, 90 x 33 mm,

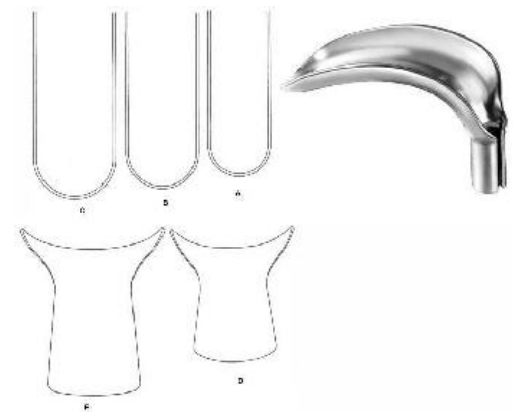

Scherbak
AS-20-125-00
Vaginal Speculum
Size 1,

SURGICAL INSTRUMENTS

GYNECOLOGY



Auvard
AS-20-126-22
Vaginal Speculum
80 x 43 mm,



Weissbarth
AS-20-127-24
Vaginal Speculum
21 cm 80 x 42 mm,



Breisky
AS-20-128-20
Vaginal Speculum
29 cm 100 x 20 mm, 29 cm 100 x 25 mm,



Kogan
AS-20-129-24
Endocervical Speculum
25 cm 70 x 30 mm,



Kogan
AS-20-130-24
Endocervical Speculum
24.5 cm,



Hegar
AS-20-131-24
Uterine Dilator
18.5 cm 1,0,

SURGICAL INSTRUMENTS

GYNECOLOGY



Hegar
AS-20-132-02
Uterine Dilator
20 cm 1,0,



Hank
AS-20-133-10
Uterine Dilator
26.5 cm Fig. 9/10,



Sims
AS-20-134-32
Uterine Sound
33 cm,



Valleix
AS-20-135-25
Uterine Sound
29.5 cm,



Braun
AS-20-136-26
Uterine Depressor
27.5 cm,



Schroder
AS-20-137-25
Uterine Tenaculum Forceps
25.5 cm,

SURGICAL INSTRUMENTS

GYNECOLOGY



Braun
AS-20-138-25
Uterine Tenaculum Forceps
26 cm,



Duplay
AS-20-139-28
Uterine Tenaculum Forceps
25.5 cm,



Beacham
AS-20-140-26
Amniotome
26 cm,



Skene
AS-20-141-24
Uterine Tenaculum Forceps
24 cm,

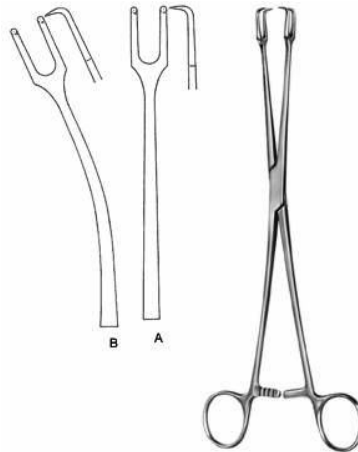

Schroder
IN-20-142-24
Uterine Tenaculum Forceps
25 cm,



Teale
AS-20-143-23
Uterine Tenaculum Forceps
23.5 cm,

SURGICAL INSTRUMENTS

GYNECOLOGY

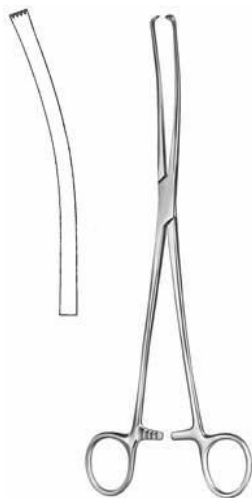

Iowa
AS-20-144-26
Uterine Tenaculum Forceps
26 cm,



Museux
AS-20-145-24
Uterine Tenaculum Forceps
24 cm,



Jacobs
AS-20-146-21
Uterine Tenaculum Forceps
21 cm,

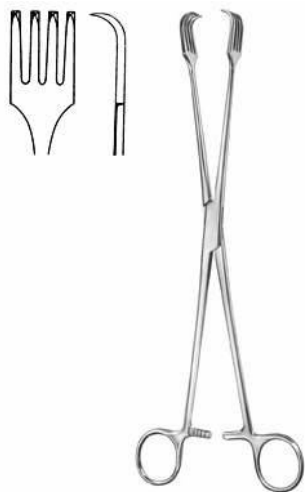

AS-20-147-26
Uterine Tenaculum Forceps
26.5 cm,



Braun
AS-20-148-16
Uterine Tenaculum Forceps
16 cm,

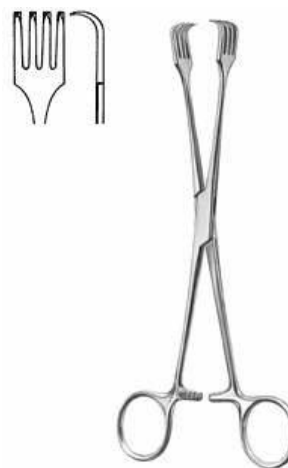

Czerny
AS-20-149-21
Uterine Tenaculum Forceps
21 cm,

SURGICAL INSTRUMENTS

GYNECOLOGY

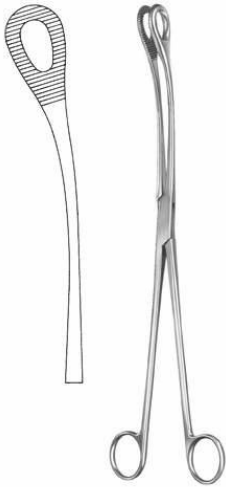

Kelly
AS-20-150-32
Uterine Polypus Forceps
32 cm,



Noto
AS-20-151-27
Uterine Polypus Forceps
27 cm,

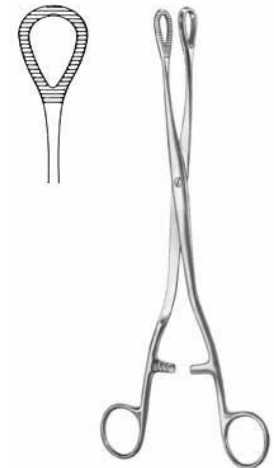

Heywood-Smith
AS-20-152-25
Uterine Polypus Forceps
25 cm,



Doyen
AS-20-153-17
Myoma Screw
17 cm,

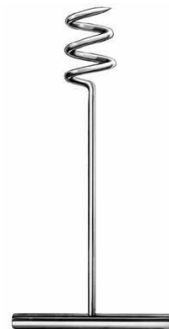

Doyen
AS-20-154-17
Myoma Screw
14.5 cm,



Segond
AS-20-155-27
Myoma Knife
28 cm,

SURGICAL INSTRUMENTS

GYNECOLOGY

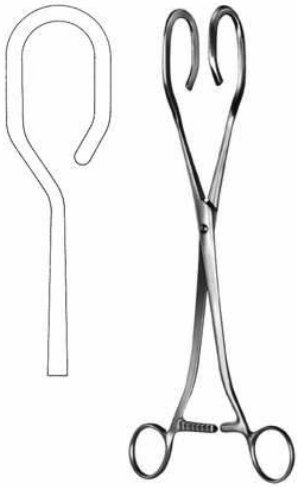

Dartigues

AS-20-156-27

Uterine Seizing Forceps
28 cm,



Somer

AS-20-157-27

Uterine Seizing Forceps
22.5 cm,



Collin

AS-20-158-25

Uterine Seizing Forceps jaw 40 mm wide
26 cm,



Ayre

AS-20-159-23

Conization Knife cutting edge 3,6 mm wide
23.5 cm,



Emmett

AS-20-160-03

Fistula Hook
22 cm Fig.3,



Simon

AS-20-161-22

Fistula Hook
21.5 cm,

SURGICAL INSTRUMENTS

GYNECOLOGY



Simon
AS-20-162-22
Fistula Hook
21.5 cm,



Novak
AS-20-163-23
Suction Curette 4 mm ?
24.5 cm,



Kevorkian
AS-20-164-23
Uterine Biopsy Curette 6,0 mm ?
30 cm,



Munchen
AS-20-165-27
Uterine Biopsy Curette 4,8 mm ?
27 cm,



Gellhorn
AS-20-166-23
Uterine Biopsy Forceps jaw 8,6 mm wide
24 cm,



Faure
AS-20-167-21
Faure Uterine Biopsy Forceps
21 cm,

SURGICAL INSTRUMENTS

GYNECOLOGY

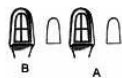

Schubert
AS-20-168-21

Uterine Biopsy Forceps jaw 4,8 mm wide
21.5 cm, 28 cm,



Thoms-Gaylor
AS-20-169-22

Uterine Biopsy Forceps jaw 5,6 mm ?
21 cm, 23.5 cm,



Schubert
AS-20-170-26

Schubert Uterine Biopsy Forceps
25.5 cm,

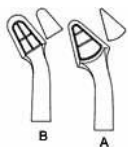

Van Doren
AS-20-171-24

Uterine Biopsy Forceps jaw 4,9 mm wide
27 cm, 25.5 cm,



Alexander
AS-20-172-28

Uterine Biopsy Forceps jaw 5,1 mm wide
28 cm,



Kevorkian
AS-20-173-32

Uterine Biopsy Forceps
25 cm,

SURGICAL INSTRUMENTS

GYNECOLOGY

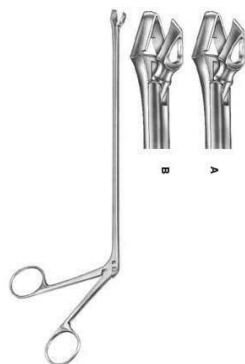

Schumacher
AS-20-174-01

Uterine Biopsy Forceps jaw 4,6 / 5,4 mm wide
24 cm,



Schumacher
AS-20-175-00

Uterine Biopsy Forceps
25 cm,



AS-20-176-22

IUP Grasping Forceps 3 mm ?
22 cm,

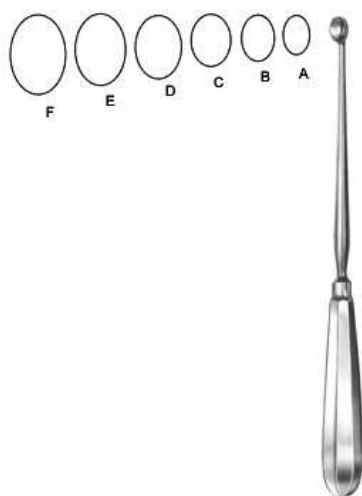

Simon
AS-20-177-01

Uterine Scoop
24.5 cm 9,8 x 8,6 mm, 24.5 cm 11,6 x 8,3 mm,



Simon

AS-20-178-01

Uterine Scoop
30 cm 9,8 x 8,6 mm, 30 cm 11,6 x 8,3 mm,



Recamier

AS-20-179-05

Uterine Curette
31 cm Fig. 00 5 mm, 31 cm Fig. 0 6 mm,

SURGICAL INSTRUMENTS

GYNECOLOGY



Recamier

AS-20-180-05

Uterine Curette

31 cm Fig. 00 5 mm, 31 cm Fig. 0 6 mm,



Sims

AS-20-181-05

Uterine Curette

31 cm Fig. 00 5 mm, 31 cm Fig. 0 6 mm,

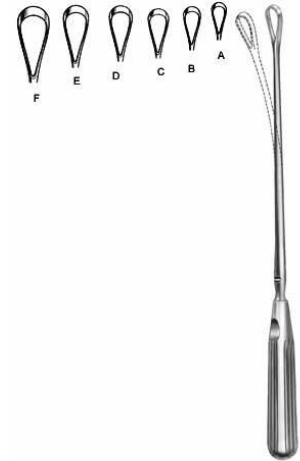

Sims

AS-20-182-05

Uterine Curette

31 cm Fig. 00 5 mm, 31 cm Fig. 0 6 mm,



AS-20-183-03

Suction Curette

29 cm 3,0 mm ?, 29 cm 4,5 mm ?, 29 cm 6,0 mm ?,

SURGICAL INSTRUMENTS

OBSTETRICS



Martin

AS-21-101-34

Pelvimeter cm, inch scale
34 cm,



Nagele

AS-5-102-36

Obstetrical Forceps
35 cm,40.5 cm,



Simpson

AS-5-103-30

Obstetrical Forceps
31 cm,



Wrigley

AS-5-104-28

Obstetrical Forceps
28 cm,



Simpson

AS-21-105-36

Obstetrical Forceps
36.5 cm,



Kielland

AS-21-106-41

Obstetrical Forceps
42 cm,

SURGICAL INSTRUMENTS

OBSTETRICS

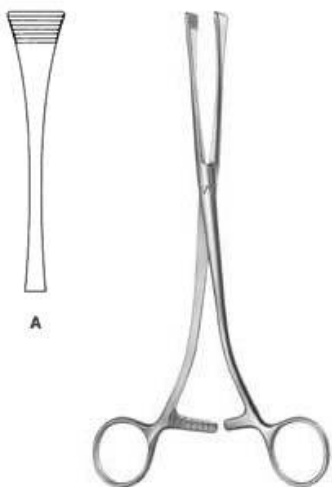

Green-Armytage
AS-21-107-21
Uterine Clamp
21 cm,



Sellheim
AS-21-108-28
Obstetrical Lever
32 cm,

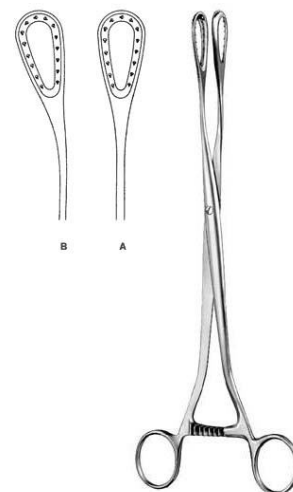

Sanger
AS-21-109-27
Placenta and Ovum Forceps
27.5 cm, 27 cm,

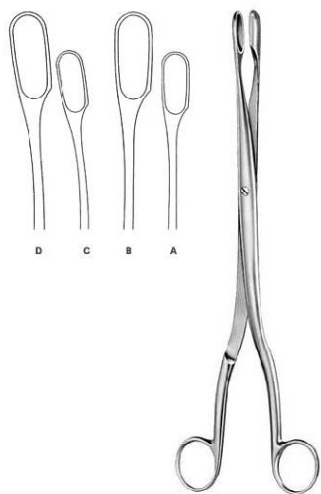

Winter
AS-21-110-01
Placenta and Ovum Forceps
28 cm Fig. 1, 28 cm Fig. 2,

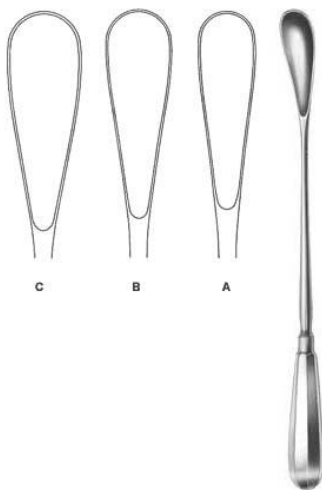

Cuzzi
AS-21-111-01
Placenta Scoop
30 cm 14,5 mm, 30 cm 18 mm,



Pestalozza
AS-21-112-30
Placenta Scoop
30 cm,

SURGICAL INSTRUMENTS

OBSTETRICS



Kane
AS-21-113-08
Umbilical Cord Clamp
8.5 cm,



Collin
AS-21-114-09
Umbilical Cord Clamp
8.5 cm,

SURGICAL INSTRUMENTS

STERILIZATION



Irrigator
AS-23-101-10
Size 1,



Round Bowl
AS-23-102-16
220 mm x 70 mm, 400 mm x 150 mm,



AS-23-103-33
Round Bowl
? x h 6,00 l,



Flat Dish
AS-23-104-11
? x h 0,20 l,



Lid only
AS-23-105-11
Size 1,



Stainless Steel
AS-23-106-04
? x h 0,30 l,

SURGICAL INSTRUMENTS

STERILIZATION



Round Dish

AS-23-107-11

? x h 0,30 l, ? 128 x 38 mm 0,40 l,



Flat Dish

AS-23-108-11

? x h 0,15 l,



Measurer

AS-23-109-01

graduated inside
100cc = 0,1 l,



Measurer

AS-23-110-02

Graduated Inside
0,25 l, 0,50 l,



Petri Dish

AS-23-111-10

with Lid ? x h



Petri Dish

AS-23-112-09

without lid ? x h
Size 1,

SURGICAL INSTRUMENTS

STERILIZATION



Lid for Petri Dishes
AS-23-113-10
Size 1,



Universal Tray
AS-23-114-23
l x b x h,



Instrument Tray
AS-23-115-21
l x b x h,



Universal Tray
AS-23-116-23
l x b x h,



Round Bowl
AS-23-117-22
? x h,



Metal Jar
AS-23-118-30
? 30mm x 90 mm, ? 50mm x 100 mm,

SURGICAL INSTRUMENTS

STERILIZATION



Instrument Box
AS-23-119-16
lid with knob
l x b x h,



Instrument Box
AS-23-120-16
lid with knob
l x b x h,



Instrument Box
AS-23-121-20
l x b x h,



Round Metal Box
AS-23-122-06
? 75 mm x 75 mm, ? 100 mm x 60 mm,



Medicine Cup Graduated Inside
AS-23-123-25
25 ccm,



Medicine Cup Graduated Inside
AS-23-124-50
50 ccm,

SURGICAL INSTRUMENTS

STERILIZATION



Tablet Tray
AS-23-125-75
? 75 mm x 12 mm,



Metal Cup
AS-23-126-90
? 90 mm x 90 mm,



Denture Cup
AS-23-127-75
? 75 mm x 50 mm,



Insert for Cup
AS-23-128-75
? 73 mm x 75 mm,



Kidney Dish
AS-23-129-17
l x b x h,



Placenta Pan
AS-23-130-36
Size 1,

SURGICAL INSTRUMENTS

STERILIZATION



Waste Cotton Collector
AS-23-131-01
? 50 mm x 75 mm,



Spirit Lamp
AS-23-132-07
120 ccm,

SURGICAL INSTRUMENTS

BONE SURGERY



Charrière
AS-7-102-35
Amputation Saw
35 cm,



Langenbeck
AS-7-103-23
Amputation Saw
24.5 cm,



Charrière
AS-7-104-27
Amputation Saw
26.5 cm,



AS-7-105-14
Reamer
13.5 cm,



Perthes
AS-7-106-18
Reamer
18 cm,

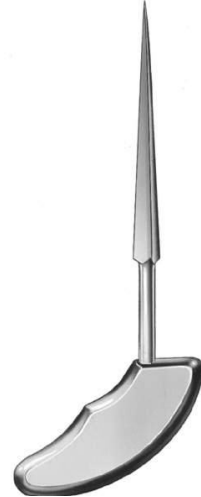

Perthes
AS-7-107-21
Reamer
21.5 cm,

SURGICAL INSTRUMENTS

BONE SURGERY



AS-7-108-14
Reamer
14 cm,



AS-7-111-18
Flat Trephine

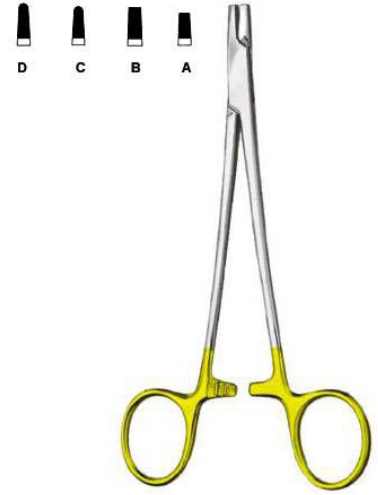

AS-7-112-01
Wire Twisting Forceps
15.5 cm, 18 cm, 20 cm,

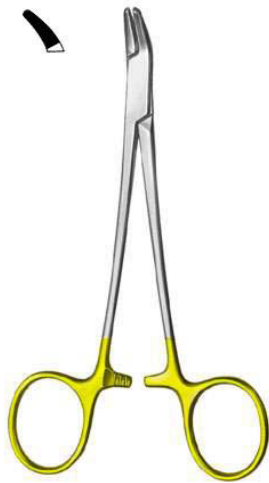

AS-7-113-15
Wire Twisting Forceps
15.5 cm,



AS-7-114-17
Flat Nose Plier
18.5 cm,



AS-7-115-18
Wire Twisting Forceps
19 cm,

SURGICAL INSTRUMENTS

BONE SURGERY



AS-7-116-15
Combi-Flat Nose Plier
15 cm,

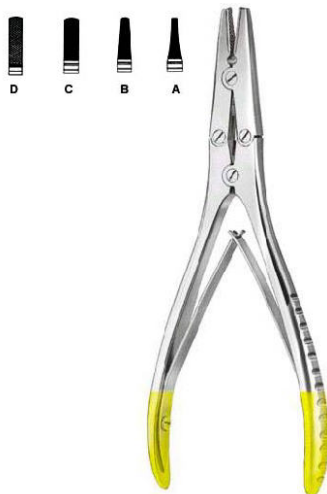

AS-7-117-01
Flat Nose Plier
18 cm,

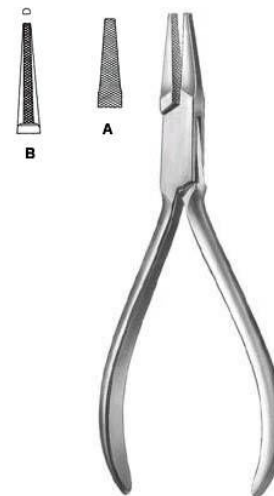

AS-7-118-14
Flat Nose Plier
13.5 cm,



Hackstock
AS-7-119-16
Flat Nose Plier
16 cm,

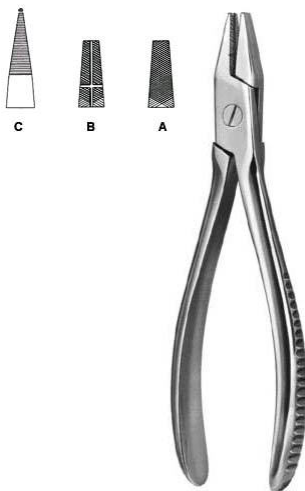

AS-7-120-01
Flat Nose Plier
17.5 cm,



AS-7-121-18
Wire Cutting Pliers
18.5 cm,

SURGICAL INSTRUMENTS

BONE SURGERY



AS-7-122-15
Wire Cutting Pliers
15 cm,



AS-7-123-18
Wire Cutting Pliers
17.5 cm,

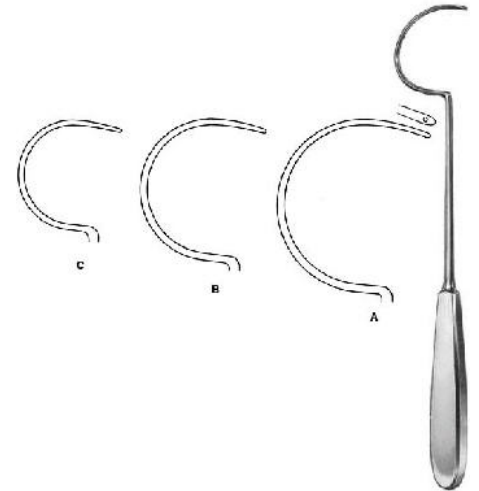

Demel
AS-7-124-18
Wire Guide
31 cm Fig. 1, 29 cm Fig. 2, 28 cm Fig. 3,

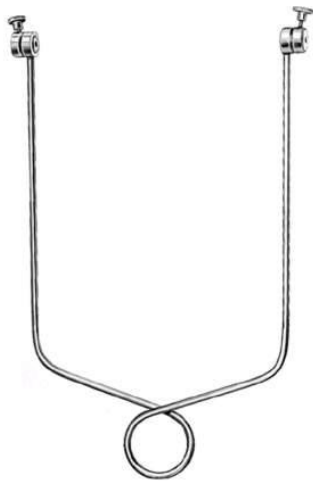

Bohler
AS-7-125-15
Extension Bow



Kirschner
AS-7-126-01
Extension Bow
18.5 cm, 26.5 cm,



AS-7-127-06
Traction Hook for Extension Bows

SURGICAL INSTRUMENTS

BONE SURGERY



Kirschner
AS-7-128-06
Wire Drill
6 cm, 12 cm,



Kirschner
AS-7-129-06
Wire Drill
14 cm, 16 cm,



Kirschner
AS-7-130-10
Wire Drill
31 cm,



Kirschner
AS-7-131-10
Wire Drill
6 cm, 12 cm, 18 cm,



Kirschner
AS-7-132-10
Wire Drill
31 cm,



Buckley
AS-7-133-02
Chisel
16 cm,

SURGICAL INSTRUMENTS

BONE SURGERY



Buckley
AS-7-134-02
Gouge
16 cm,



Stout
AS-7-135-03
Bone Chisel
21 cm,



AS-7-136-04
Bone Chisel
18 cm,



AS-7-137-04
Bone Chisel
18 cm,



AS-7-138-04
Bone Chisel
17 cm,



AS-7-139-04
Bone Chisel
17 cm,

SURGICAL INSTRUMENTS

BONE SURGERY

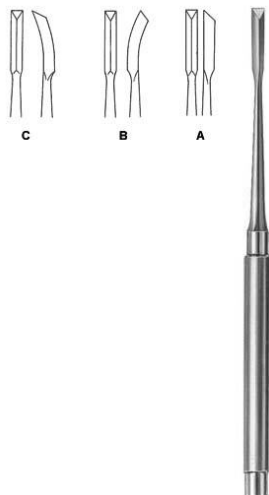

Gardner
AS-7-140-01
Bone Chisel
17 cm 4mm,



Snyder-O.S.U.
AS-7-141-03
Bone Chisel
16.5 cm 3mm, 16.5 cm 5.5mm,



O.S.U.
AS-7-142-01
one Chisel
17 cm 7mm,



O.S.U.
AS-7-143-01
one Chisel
17 cm 9mm,



AS-7-144-08
Osteotome
13.5 cm 8mm, 13.5 cm 10mm, 13.5 cm
12mm, 13.5 cm 14mm, 13.5 cm 16mm,



AS-7-145-08
Chisel
13.5 cm 8mm, 13.5 cm 10mm, 13.5 cm
12mm, 13.5 cm 14mm, 13.5 cm 16mm,

SURGICAL INSTRUMENTS

BONE SURGERY



AS-7-146-08

Gouge

13.5 cm 8mm, 13.5 cm 10mm, 13.5 cm 12mm, 13.5 cm 14mm, 13.5 cm 16mm,



Partsch

AS-7-147-02

Chisel

13.5 cm 2mm, 13.5 cm 3mm, 13.5 cm 4mm, 13.5 cm 5mm, 13.5 cm 6mm, 17 cm 2mm, 17 cm 3mm, 17 cm 4mm, 17 cm 5mm, 17 cm 6mm,



Partsch

AS-7-148-02

Gouge

13.5 cm 2mm, 13.5 cm 3mm, 17 cm 2mm, 17 cm 3mm,

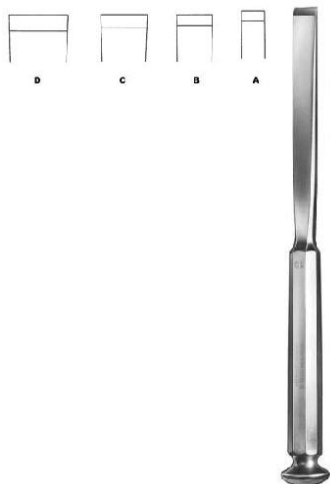

Stille

AS-7-149-10

Chisel

20 cm 10mm, 20 cm 15mm, 20 cm 20mm, 20 cm 25mm,



Stille

AS-7-150-10

Osteotome

20 cm 10mm, 20 cm 15mm, 20 cm 20mm, 20 cm 25mm,



Stille

AS-7-151-10

Gouges

20 cm 10mm, 20 cm 15mm, 20 cm 20mm, 20 cm 25mm,

SURGICAL INSTRUMENTS

BONE SURGERY



Lambotte, Mini
AS-7-152-02

Osteotome
12.5 cm 2mm, 12.5 cm 3mm, 12.5 cm 4mm, 12.5 cm 6mm, 12.5 cm 8mm,



Lambotte
AS-7-153-15

Osteotome
24 cm 15mm, 24 cm 20mm, 24 cm 25mm, 24 cm 30mm,



Lambotte
AS-7-154-15

Osteotome
24 cm 15mm, 24 cm 20mm, 24 cm 25mm, 24 cm 30mm,



Smith-Petersen
AS-7-155-06

Osteotome
20.5 cm 6mm, 20.5 cm 9mm, 20.5 cm 13mm,



Smith-Petersen
AS-7-156-06

Osteotome
20.5 cm 6mm, 20.5 cm 9mm, 20.5 cm 13mm, 20.5 cm 16mm, 20.5 cm 19mm,



Smith-Petersen
AS-7-157-09

Gouge
20.5 cm 9mm, 20.5 cm 14mm, 20.5 cm 19mm, 20.5 cm 25mm,

SURGICAL INSTRUMENTS

BONE SURGERY



Smith-Petersen
AS-7-158-09

Gouge
20.5 cm 9mm, 20.5 cm 14mm, 20.5 cm 19mm,



Hoke
AS-7-159-03

Osteotome
17 cm 3mm, 17 cm 5mm, 17 cm 6mm, 17 cm 8mm,

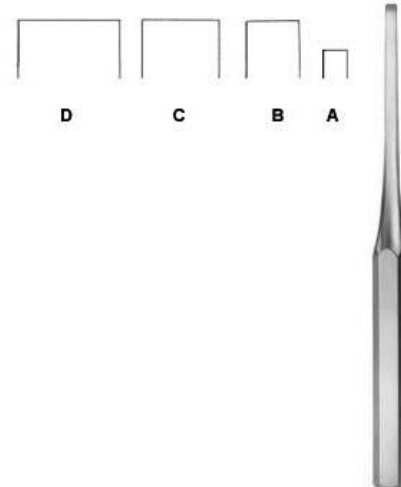

Hibbs
AS-7-160-06

Osteotome
24.5 cm 6mm, 24.5 cm 13mm, 24.5 cm 19mm,

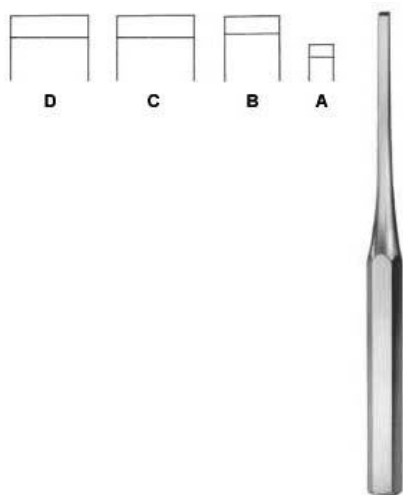

Hibbs
AS-7-161-06

Chisel
24.5 cm 6mm, 24.5 cm 19mm, 24.5 cm 13mm,

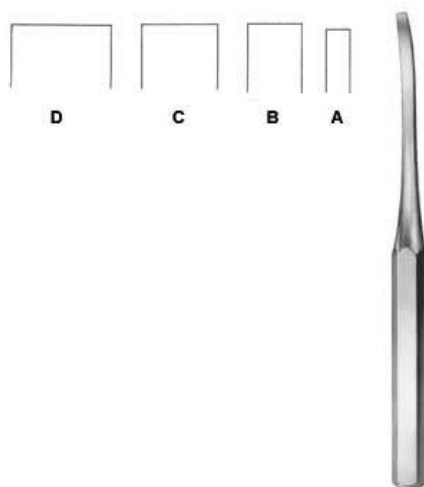

Hibbs
AS-7-162-06

Osteotome
24.5 cm 6mm, 24.5 cm 13mm, 24.5 cm 19mm,

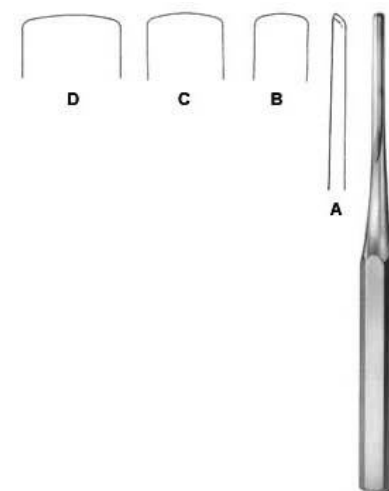

Hibbs
AS-7-163-06

Hibbs
24.5 cm 6mm, 24.5 cm 13mm, 24.5 cm 19mm,

SURGICAL INSTRUMENTS

BONE SURGERY

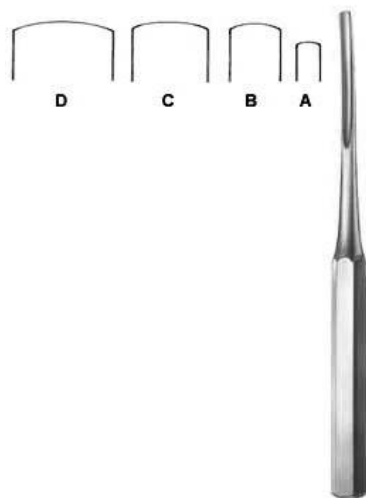

Hibbs
AS-7-164-06

Gouge
24.5 cm 6mm, 24.5 cm 13mm, 24.5 cm
19mm,

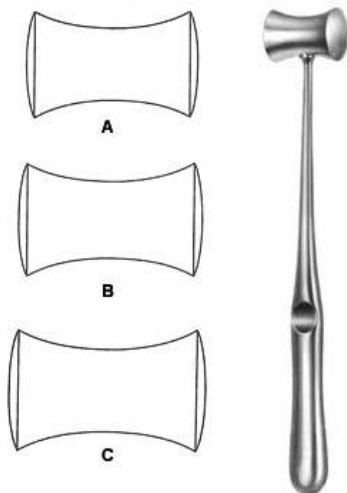

Williger
AS-7-165-01

Mallet
24 cm,

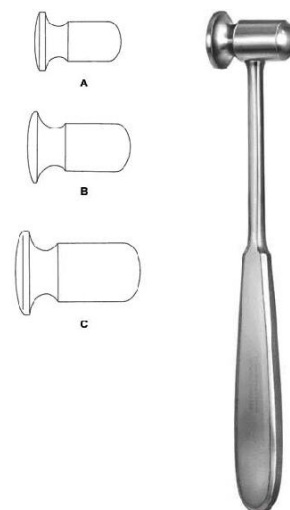

Doyen
AS-7-166-01

Mallet
20.5 cm, 21 cm, 21.5 cm,



Collin
AS-7-167-20

Mallet
20 cm,

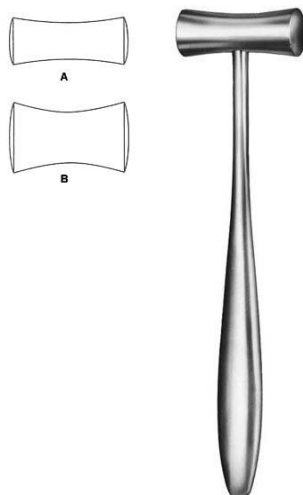

Lucae
AS-7-168-01

Mallet
19.5 cm,



Cottle
AS-7-169-19

Mallet
19 cm,

SURGICAL INSTRUMENTS

BONE SURGERY



Williger
AS-7-170-01
Mallet
16.5 cm,



Mead
AS-7-171-17
Mallet
19 cm,



Partsch
AS-7-172-18
Mallet
19 cm,



Schede
AS-7-173-01
Bone Curette Fig. 0 to 4
17 cm,

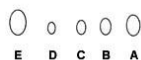

Volkman
AS-7-174-01
Bone Curette
17 cm Fig. 0, 17 cm Fig. 00, 17 cm Fig. 000, 17 cm Fig. 1, 17 cm Fig. 2, 17 cm Fig. 3, 17 cm Fig. 4,



Bruns
AS-7-175-01
Bone Curette
17 cm Fig. 0, 17 cm Fig. 00, 17 cm Fig. 000, 17 cm Fig. 1, 17 cm Fig. 2, 17 cm Fig. 3, 17 cm Fig. 4,

SURGICAL INSTRUMENTS

BONE SURGERY



Spratt

AS-7-176-01

Bone Curette

17 cm Fig. 0, 17 cm Fig. 00, 17 cm Fig. 000, 17 cm Fig. 0000, 17 cm Fig. 1, 17 cm Fig. 2, 17 cm Fig. 3, 17 cm Fig. 4, 17 cm Fig. 5,

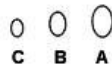

Bruns

AS-7-177-01

Bone Curette

23 cm Fig. 0, 23 cm Fig. 00, 23 cm Fig. 000, 23 cm Fig. 1, 23 cm Fig. 2, 23 cm Fig. 3,

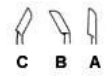

Scoville

AS-7-178-25

Bone Curette

25 cm,



Simon

AS-7-179-01

Bone Curette

25 cm Fig. 1, 25 cm Fig. 2, 25 cm Fig. 3, 25 cm Fig. 4, 25 cm Fig. 5,



Modell USA

AS-7-180-01

Bone Curette

16 cm Fig. 1, 16 cm Fig. 2, 16 cm Fig. 3, 16 cm Fig. 4,

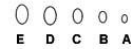

Modell USA

AS-7-181-01

Bone Curette

15.5 cm Fig. 1, 15.5 cm Fig. 2, 15.5 cm Fig. 3, 15.5 cm Fig. 4,

SURGICAL INSTRUMENTS

BONE SURGERY



Modell USA
AS-7-182-01

Bone Curette

15.5 cm Fig. 1, 15.5 cm Fig. 2, 15.5 cm Fig. 3, 15.5 cm Fig. 4,



Halle

AS-7-183-01

Bone Curette

21 cm Fig. 1, 21 cm Fig. 2, 21 cm Fig. 3,



Volkman

AS-7-184-01

Bone Curette, double-ended
12.5 cm, 14.5 cm, 17 cm,



Volkman

AS-7-185-13

Bone Curette, double-ended
13 cm, 16 cm,



AS-7-186-21

Bone Curette, double-ended
21 cm,



Williger

AS-7-187-00

Bone Curette, double-ended
13.5 cm Fig. 00/0, 13.5 cm Fig. 0/1, 13.5 cm
Fig. 1/2,

SURGICAL INSTRUMENTS

BONE SURGERY



Hemingway
AS-7-189-11
Bone Curette, double-ended
18 cm,



Hemingway
AS-7-190-00
Bone Curette, double-ended
18.5 cm,



AS-7-191-01
Bone Curette, double-ended
17.5 cm,

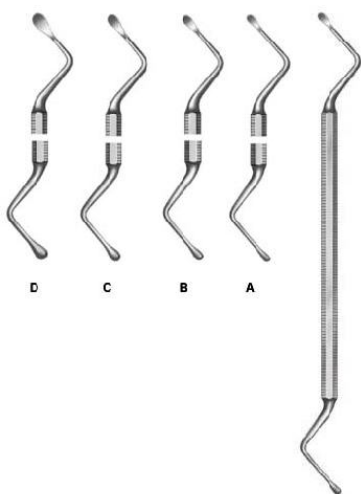

Lucas
AS-7-192-11
Bone Curette, double-ended
18 cm,

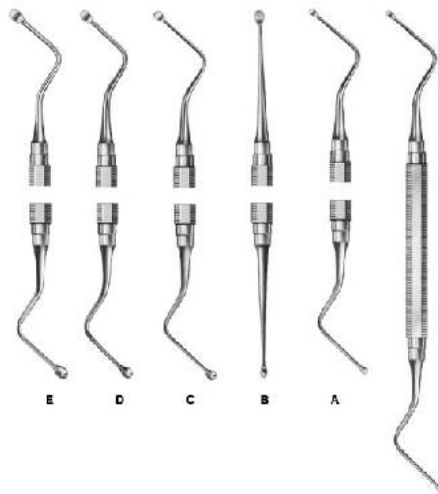

Miller-Colburn
AS-7-193-00
Bone Curette, double-ended
17 cm Fig. 0, 17 cm Fig. 1, 17 cm Fig. 2, 17 cm Fig. 3,

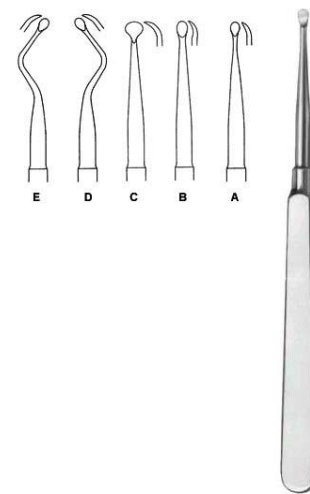

Molt
AS-7-194-01
Bone Curette
17 cm Fig. 1, 17 cm Fig. 2, 17 cm Fig. 3, 17 cm Fig. 4,

SURGICAL INSTRUMENTS

BONE SURGERY

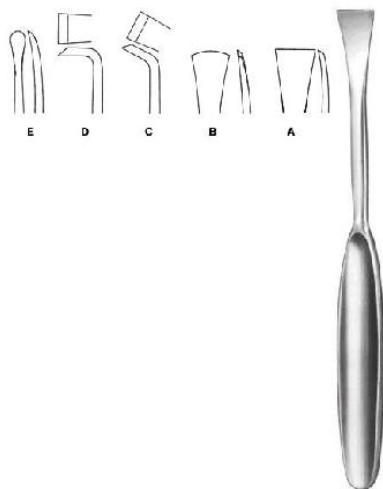

Martin-Langenbeck
AS-7-195-01
Periosteal Elevator
19 cm 16mm,



Langenbeck
AS-7-196-18
Periosteal Elevator
18.5 cm,



Langenbeck
AS-7-197-19
Periosteal Elevator
19.5 cm,



AS-7-198-05
Periosteal Elevator
16 cm 5mm, 16 cm 6mm, 16 cm 7mm,

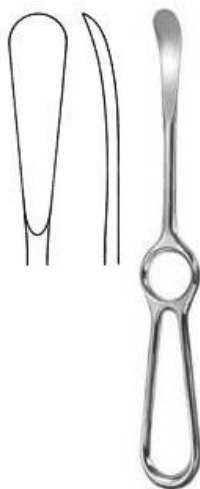

Sedillot
AS-7-199-21
Periosteal Elevator
22 cm 15mm,



Williger
AS-7-200-13
Periosteal Elevator
12.5 cm 5mm,

SURGICAL INSTRUMENTS

BONE SURGERY



Kahre-Williger
AS-7-201-04
Periosteal Elevator
4 mm, 5 mm, 7 mm,

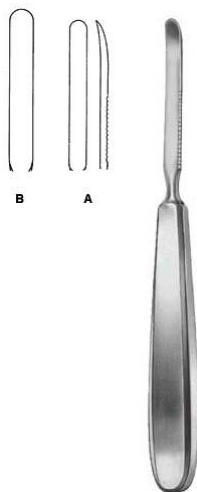

AS-7-202-06
Periosteal Elevator
17 cm 6 mm, 17 cm 8 mm,



Doyen
AS-7-203-17
Rib Raspatory
17.5 cm,

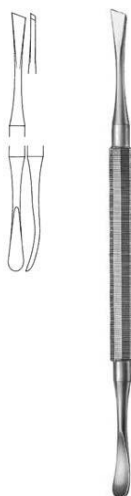

West
AS-7-204-19
Periosteal Elevator, double-ended
18.5 cm,



Ohl
AS-7-205-17
Periosteal Elevator, double-ended
17.5 cm,



Semb
AS-7-206-01
Periosteal Elevator
18.5 cm Fig. 1, 21.5 cm Fig. 2,

SURGICAL INSTRUMENTS

BONE SURGERY



AS-7-207-22
Bone File
22 cm,

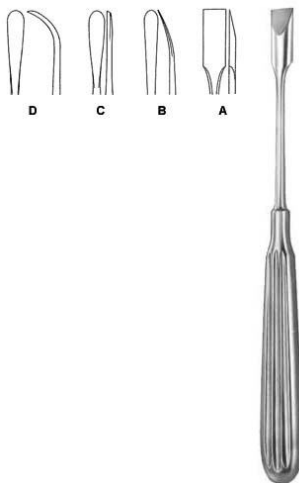

Adson
AS-7-208-17
Elevator
17 cm, 17.5 cm,

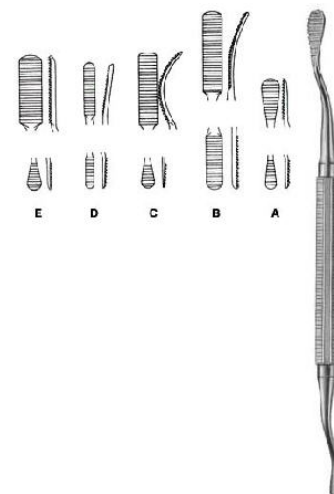

Miller-Colburn
AS-7-209-01
Bone File
18 cm Fig. 1, 18 cm Fig. 2, 18 cm Fig. 3, 18 cm Fig. 4, 18 cm Fig. 5,

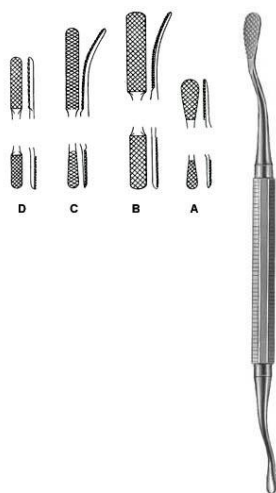

Miller-Colburn
AS-7-210-01
Bone File
18 cm Fig. 1, 18 cm Fig. 2, 18 cm Fig. 3, 18 cm Fig. 4,



Langenbeck
AS-7-211-20
Elevator
19.5 cm 8 mm, 19.5 cm 10 mm,

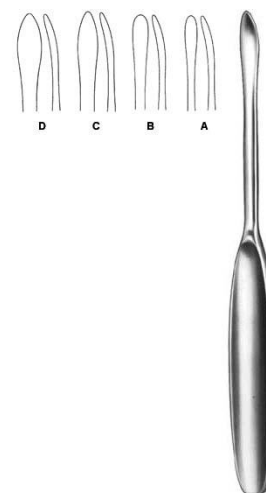

Martin-Langenbeck
AS-7-212-01
Elevator
17 cm 5 mm, 17 cm 7 mm, 17 cm 8 mm,

SURGICAL INSTRUMENTS

BONE SURGERY

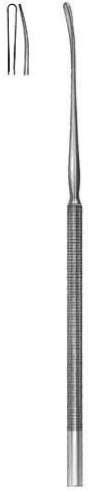

Vickers
AS-7-213-17
Elevator
17 cm,



Vickers
AS-7-214-17
Dissector
17 cm,



Williger
AS-7-215-17
Elevator
16 cm 5,5 mm,



Williger
AS-7-216-16
Elevator
16 cm 5,5 mm,



Mead
AS-7-217-17
Mallet
19 cm,



AS-7-218-18
Periosteal Elevator

SURGICAL INSTRUMENTS

BONE SURGERY



Hohmann
AS-7-219-43
Bone Lever
23.5 cm,



Lempert
AS-7-220-19
Bone Rongeur
19 cm,



Luer
AS-7-221-17
Bone Rongeur
18.5 cm, 18 cm,



Zaufal-Jansen
AS-7-222-18
Bone Rongeur
18 cm,

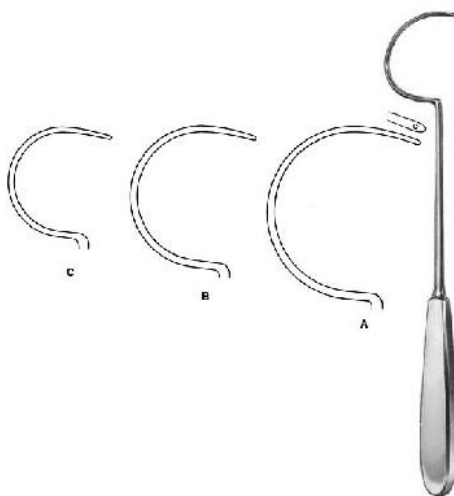

Demel
AS-7-124-01
Wire Guide
31 cm Fig. 1, 29 cm Fig. 2, 28 cm Fig. 3,

Contact Us

Address: Usman Nagar Bonkan, Sialkot- 51310, Pakistan

Cell: +92-346-6634928

Email: info@ascendersurgical.com

Email: ascendersurgicalco@gmail.com

URL: www.ascendersurgical.com



Ascender Surgical

Usman Nagar Bonkan, Sialkot- 51310, Pakistan
Cell: +92-346-6634928

Email: info@ascendersurgical.com